



sixteen **5** hundred

bringing ideas to light

ACULUX®

gotham®

LITHONIA
LIGHTING

MARK
ARCHITECTURAL LIGHTING

EUREKA



Table of Contents

- 1 Indoor
- 7 Industrial
- 8 Downlighting
- 12 Emergency
- 13 Outdoor
- 18 Eureka Guide

Slot 2 and Slot 4

LED Linear Recessed

- Blending a modern aesthetic with unparalleled performance, SLOT 2 and SLOT 4 LED recessed create simple lines of light
- Energy efficiency, design flexibility and seamless control make this recessed fixture a brilliant addition to any design
- Unparalleled flexibility: Multiple lumen packages and color temperatures available
- Unprecedented performance: Best-in-class efficacy, delivered lumens, and CRI

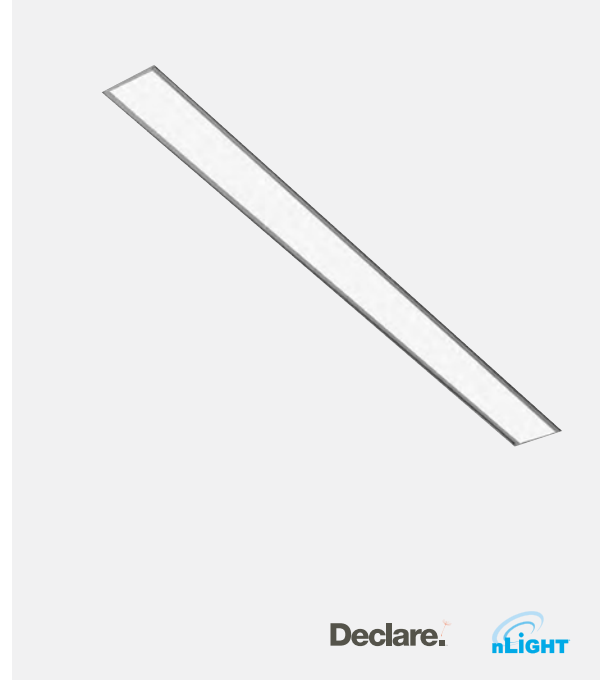

SL2L LOP 4FT FLP FL 80CRI 35K 1000LMF MIN1 120 ZT
Prices starting at \$353

SL2L LOP 8FT FLP FL 80CRI 35K 1000LMF MIN1 120 ZT
Prices starting at \$706



Description

SPRLED U4 RLP FL 80CRI 35K 1000LMF MIN10 MVOLT ZT
Prices starting at \$567

SPRLED U8 RLP FLP FL 80CRI 35K 1000LMF MIN10 MVOLT ZT
Prices starting at \$1,133

SPR

Perimeter, Recessed

- SPR LED combines the environmental and cost-saving benefits of solid-state lighting with the popular SP design. The result is a recessed linear wall product that provides an excellent balance of efficiency and performance
- With lengths ranging between 2 ft. to 8 ft., use SPR to create continuous runs of light
- SPR frosted acrylic lens diffuses light for a consistent glow



Lithonia Lighting®

BLWP

BLWP Wraparound

- Flexibility of performance: Lumen packages from 800 to 20,000 can meet nearly any lighting requirement
- Efficiency in operation: Efficacies up to 140 LPW maximize energy savings and rebates
- Versatility with controls: Control an entire campus or a single room with wired or wireless technology
- Adaptability through mounting: Mount to the ceiling, wall, surface, or suspend to accommodate any design

Description
 BLWP4 30L ADP EZ1 LP835
 Prices starting at \$120

Lithonia Lighting®

CLX

Linear LED Strip Light

- CLX features an architectural design, built to perform
- Lens and distribution options provide optics tailored for each application, including up to 13% uplight with the wide lens. The CLX can be configured to direct light output where it is needed most. Wide lens and compact reflector options can be used to minimize its Unified Glare Rating, the perceived discomfort of high angle light
- Sleek continuous rows are simple with the included row aligner bracket, providing for ease of installation and labor savings
- CLX is built to withstand the heat commonly found in applications with heavy duty electrical equipment or higher mounting heights



Description
 CLX L48 4000LM SEF FDL MVOLT EZ10 40K 80CRI WH
 Prices starting at \$121

CLX L96 8000LM SEF FDL MVOLT EZ1 40K 80CRI WH
 Prices starting at \$203

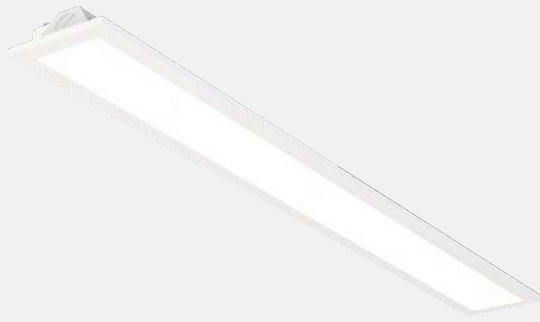

Lithonia Lighting®

LSIX

Lithonia® Six LED Linear Lay-In

- Provides modern design, ease of install and is environmentally responsible
- Ideal choice for high-quality, cost-effective LED lighting solution for schools, offices, retail, healthcare facilities and other commercial spaces

Description

LSIX 4FT 3000LM 80CRI 35000K FFR SWI MIN1 ZT MVOLT MW
Prices starting at \$138

LSIX 8FT 4000LM 80CRI 3500K FFR SWI MIN1 ZT MVOLT MW
Prices starting at \$244



Mark Architectural Lighting™

PLANAR

Indirect/Direct Pendant

- The Planar cable-suspended pendant features a low profile and energy efficiency
- Direct and indirect distributions: Select from 70/30, 50/50, 30/70, or 10/90 indirect/direct intensity ratios
- High performance batwing distribution: Injection-molded optics and straight blade baffle for optimal visual comfort
- Planar participates in Declare

Description

PLN8 U4 80CRI 35K ID1500LMF 30/70 SCT MIN1 MVOLT WHSG ZT
Prices starting at \$151

PLN8 U8 80CRI 35K ID1500LMF 30/70 SCT MIN1 MVOLT WHSG ZT
Prices starting at \$33



Mark Architectural Lighting™

PILLAR

Indirect/Direct Pendant

- Combining a classic form factor and elevated optical performance, the Pillar cable-suspended pendant adds a minimalist element to classrooms, commercial offices, and hospitality spaces
- Direct and indirect distributions: Up to 1,000 LMF direct and 1,300 LMF indirect
- Design Versatility: Select from 4' and 8' sections with flat end caps
- High performance batwing distribution: Injection-molded optics and straight blade baffle for optimal visual comfort
- Pillar participates in Declare

Description

PLLR10ID U4 80CRI 35K 1000LMF I1300LMT SCT MIN1 MVOLT WHSG ZT
starting at \$255

PLLR10ID U8 80CRI 35K 1000LMF I1300LMF SCT MIN1 MVOLT WHSG ZT
Prices starting at \$446



Lithonia Lighting®

BLT Series

Low-Profile Recessed LED Luminaire

- Flicker-free dimming – eldoLED® 1% drivers
- Choose how you control – Control an entire campus or a single room with nLight® Networked Lighting Controls
- Maximum rebate opportunities – DLC Standard and Premium listed on most configurations

Description

2BLT2 33L ADP EZ1 LP835
Prices starting at \$125

2BLT4 40L ADP EZ1 LP835
Prices starting at \$147



Mark Architectural Lighting™

WHISPER

WHSPR Troffer and WHSPR LCTR Troffer

- Offering two design options, fully luminous and luminous center (LCTR), Whisper maintains a quiet ceiling in 2'x2' and 2'x4' sizes
- Gently sloping side panels provide Whisper with depth and appealing angles
- Whether applied in rows or individually, Whisper brightens grid ceilings in offices, schools, hospitals, and other institutional settings with an artful, and simple look
- Whisper participates in Declare

Description

WHSPR 2X2 80CRI 35K 4000LM MIN1 MVOLT SWC ZT
Prices starting at \$270

WHSPR 2X4 80CRI 35K 4000LM MIN1 MVOLT SWC ZT
Prices starting at \$316



Lithonia Lighting®

STACK™

LED Center Element Lay-In

- The wide center basket and curved matte reflector allow STACK to deliver a high quality of light while maintaining optimal performance
- Features a Low Unified Glare Rating (UGR) providing consistent and efficient light distribution for enhanced visual comfort
- The STACK luminaire is available with wireless networked embedded controls from nLight®, addressing the requirements of Luminaire Level Lighting Controls (LLLC). An nLight AIR sensor is embedded with in this luminaire.
- Long-life LED's, coupled with high-efficiency drivers provide superior quality of light and an extended service life. 80% LED lumen maintenance at 60,000 hours (L80/60,000). 0-10 volt dimming driver, dims to 1%.

Description

STAK 2X2 3000LM 80CRI 35K COL MIN1 ZT MVOLT
Prices starting at \$132

STAK 2X4 4000LM 80CRI 35K COL MIN1 ZT MVOLT
Prices starting at \$83

Lithonia Lighting®

CPX

Configurable LED Panel

- Fully luminous backlit panel available in 1'x4', 2'x2', and 2'x4' sizes
- Available with lumen packages ranging from 3,200 to 10,000 lumens
- Wide range of configurable options
- Ideal for budget-conscious schools, commercial offices, retail, healthcare, and educational spaces



Description

CPX 1X4 ALO7 SWW7 M4

Prices starting at \$66

CPX 2X2 ALO7 SWW7 M4

Prices starting at \$62

CPX 2X4 ALO8 SWW7 M2

Prices starting at \$75

Lithonia Lighting®

IBG

I-BEAM® Configurable LED High Bay

- The most popular high bay in North America and an ideal one-for-one replacement for conventional HID and fluorescent high bay systems
- Standard 6KV Surge Protection tested to ANSI Industrial standards
- Compact form factor and fewer components make it easier to handle during installation, while high-efficiency options enable mounting heights up to 60 feet
- 12,000 to 72,000 lumens with high-ambient options up to 131°F (55°C) and high efficiency options greater than 180+ LPW
- Available with wireless and individual controls to increase your energy savings
- Designed for applications such as warehouses, manufacturing facilities, gymnasiums and other large indoor spaces



Description
IBG 12L MVOLT 5K
Prices starting at \$199

IBG 24L MVOLT 5K
Prices starting at \$320

ZACVH M100 - 10' aircraft cable
Prices starting at \$42



Lithonia Lighting®

CPHB

Compact Pro™ LED High Bay

- 12,000 to 60,000 lumens
- Ultra Compact - up to 50% smaller than the typical high bay, while illuminating the same amount of space as fixtures four times the length
- Contractor-friendly job pack design allows for 30% reduction in labor time and helps minimize packaging waste by 75%
- Glare reduction optics featuring WhiteOptics® technology allows for maximum light output while reducing glare
6kV ANSI Surge, 55°C ambient operation >135 lumens per watt
- Ideal solution for warehouse, general open spaces, gymnasium, and light-duty industrial spaces

CPHB 12000LM SEF GCL MD MVOLT GZ10 40K 80CRI DWH
Prices starting \$114

CPHB 24000LM SEF GCL MD MVOLT GZ10 40K 80CRI DWH
Prices starting at \$171

ZACVH M100 - 10' aircraft cable
Prices starting at \$42

Lithonia Lighting®

FEM LED

FEM LED Linear

- Available in 2-foot (L24), 4-foot (L48), and 8-foot (L96) lengths
- Sleek appearance, low-profile design and numerous options make this an ideal choice for parking garages, industrial facilities, retail stores, garden centers, food service, and airports
- Lumen packages ranging from 2,000 to 24,000 lumens with efficacy up to 170LPW
- Multiple variations of both polycarbonate and acrylic lenses available

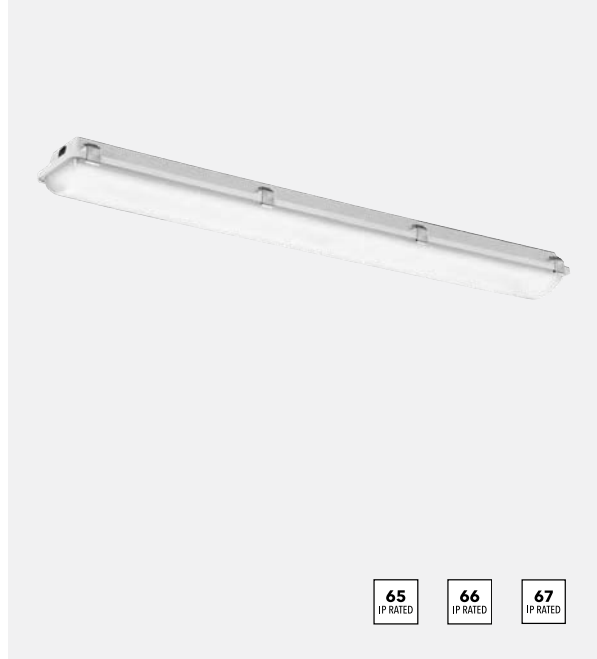

65
IP RATED

66
IP RATED

67
IP RATED

Description

FEM L48 6000LM IMAFL MD MVOLT GZ10 40K 80CRI
Prices starting at \$231

FEM L96 12000LM IMAFL MD MVOLT GZ10 40K 80CRI
Prices starting at \$450

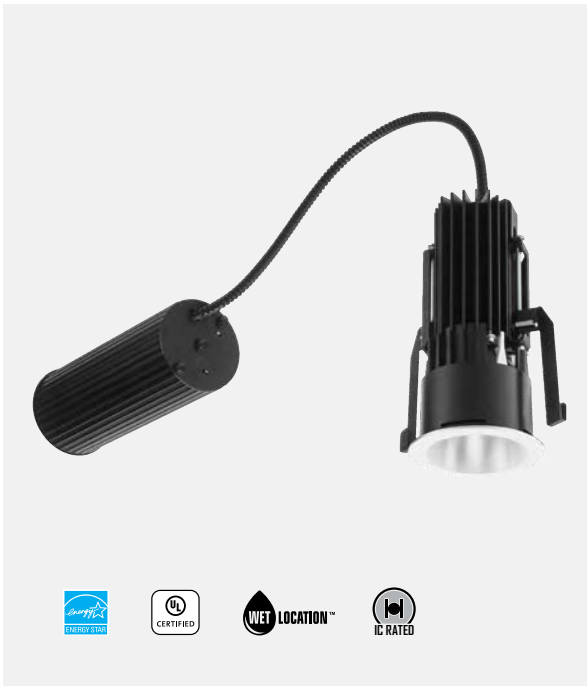

Gotham®

Incito™ 2" Round Downlight

High Center Beam LED Downlight

- Incito™ high intensity distributions provide narrow field angles to create sharp contrast with crisp highlights and deep shadows for a dramatic layer of light
- Because of its size, it can be mounted in very tight spaces without compromising exceptional output of up to 2,000 lumens, while providing an extensive array of options in trims, beam spreads, controls, CRI, apertures, finishes, and more
- Designed as an install-from-below downlight for simple installation and field interchangeable optics for easy maintenance to save time and money
- Ideal for task, directional, and accent lighting

Description

ICO2 35/10 35D MVOLT UGZ HSG
Prices starting at \$153

ICO2 AR LD TRIM U
Prices starting at \$37

Gotham®

Incito™ 4" Round Downlight

High Center Beam LED Downlight

- Incito™ high intensity distributions provide narrow field angles to create sharp contrast with crisp highlights and deep shadows for a dramatic layer of light
- Choose from an extensive array of options in trims, beam spreads, controls, CRI, apertures, finishes, and more
- Fully serviceable and upgradeable lensed LED light engine is suitable for field maintenance or service from below the ceiling to save time and money
- Ideal for task, directional, and accent lighting



Description
ICO4 35/20 35D 120 EZ1 HSG
Prices starting at \$176

ICO4 AR LD TRIM U
Prices starting at \$36



Description
EVO2 35/15 90CRI MWD MVOLT UGZ HSG
Prices Starting at \$153

EVO2 AR LD TRIM U
Prices starting at \$37

EVO4 35/15 90CRI MWD MVOLT EZ1 HSG
Prices starting at \$178

EVO4 AR LD TRIM U
Prices starting at \$37

EVO6 35/15 90CRI MWD MVOLT EZ1 HSG
Prices starting at \$178

EVO6 AR LD TRIM U
Pricing starting at \$37

Gotham®

EVO® 2" Round Downlight

General Illumination LED Downlight

- EVO® batwing distribution provides a uniform, wide angled general illumination on horizontal and vertical surfaces to create smooth edges and an even layer of light without hot spots or rings
- With a small size, EVO 2" still provides best-in-class spacing and superior glare control with 50° cutoff to source and top down flash characteristics for general illumination
- Fully serviceable and upgradeable lensed LED light engine is suitable for field maintenance or service from below the ceiling to save time and money
- High performance combined with visual elegance, delivered at a level of energy efficiency of 70% lumen maintenance at 60,000 hours



Aculux®

Initia 3"

New Construction Round Downlight

- Comprehensive family (Downlight, Adjustable, Wall Wash) of versatile, elegant precision recessed luminaires
- Up to 1500 lumens, 2-step binning and excellent color rendition
- Adjustable accent luminaire features 0°– 35° vertical and 359° horizontal aiming
- Superb 45° visual cut-off for a truly quiet ceiling
- Ideal choice for residential, commercial and hospitality applications

Description

INIT3 A 15LM 35K 80CRI 50D EZ1 MVOLT
Prices starting at \$108

INIT3 D 15LM 35K 80CRI 50D EZ1 MVOLT
Prices starting at \$86

NT3DBV BD WHSF
Prices starting at \$35

Aculux®

Initia 3"

New Construction Square Downlight

- Comprehensive family (Downlight, Adjustable, Wall Wash) of versatile, elegant precision recessed luminaires
- Up to 1500 lumens, 2-step binning and excellent color rendition
- Adjustable accent luminaire features 0°– 35° vertical and 359° horizontal aiming
- Superb 45° visual cut-off for a truly quiet ceiling
- Ideal choice for residential, commercial and hospitality applications

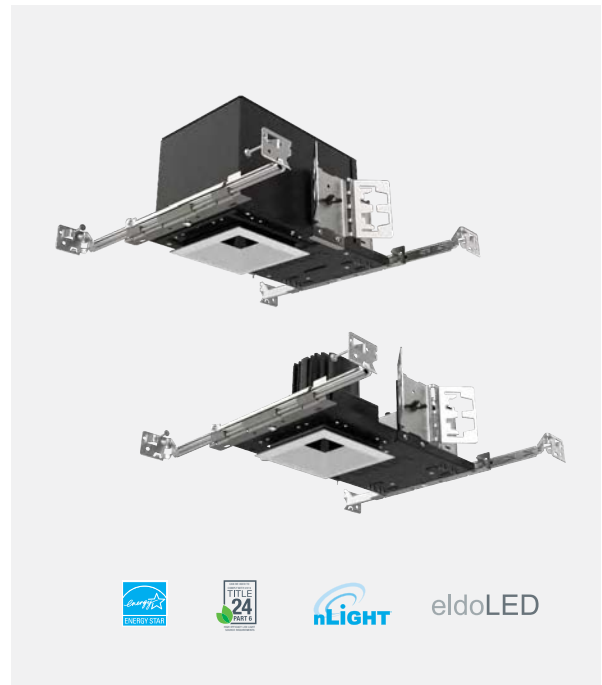

Description

INIT3SQ A 15LM 35K 80CRI 50D EZ1 MVOLT
Prices starting at \$108

INIT3SQ D 15LM 35K 80CRI 50D EZ1 MVOLT
Prices starting at \$86

NT3SQDBV BD WHSF
Prices starting at \$35

Lithonia Lighting®

LDN4/LDN6

LDN4/LDN6 Switchable

- LDN 4" and 6" open downlight and wall wash for everyday general illumination comes with a switchable driver with 4 CCT options and adjustable lumen output
- Available with a remarkable set of options and features making it the best value in commercial downlighting
- Save time and money with quick installation times using traditional recessed installation frames and flexibility with switchable CCT and lumens
- Most cost-effective general illumination solution that allows for a quiet, glare-free ceiling without compromising on efficacy over 100 LPW
- Typical applications include corridors, lobbies, conference rooms, classrooms, retail, hospitality, and offices



Description

LDN4 ALO2 SWW1 MVOLT UGZ HSG
Prices starting at \$109

LO4 AR LSS TRIM
Prices starting at \$28

LW4 AR LSS TRIM
Prices starting at \$47

LDN6 ALO2 SWW1 MVOLT UGZ HSG
Prices starting at \$109

LO6 AR LSS TRIM
Prices starting at \$28

LW6 AR LSS TRIM
Prices starting at \$47



Lithonia Lighting®

EDG/EDGR

LED Edge-Lit Exits

- Sealed, maintenance-free nickel-cadmium battery delivers 90 minutes capacity to emergency lamps
- Extruded aluminum (standard) or white finish lamp housing
- Clear thermoplastic panels and mirrored separator panel to simulate clear background
- Dual voltage capability (120/277V)
- Universal surface (top, end, or back) mounting with canopy provided

Description

EDG 1 GMR M6

Prices starting at \$133

EDGR 1 GMR M4

Prices starting at \$221

Lithonia Lighting®

EDG/EDGR

LED Edge-Lit Basics



Description

BE W G UM M2 UNIVERSAL MOUNT

Prices starting at \$93



Lithonia Lighting®

ELM4L/ELM6L

Quantum® LED Emergency Light

- Unique track and swivel arrangement permits full range of direction for lamp head adjustment
- High performance LEDs with acrylic lens' rated at 1.2 watts each
- Sealed, maintenance-free nickel-cadmium battery
- Wall mount and ceiling mount standard

Description

ELM4L

Prices starting at \$99

ELM2L M12

Prices starting at \$42

Lithonia Lighting®

D-Series Size 0

LED Area Luminaire

- With up to 21,000 lumens, DSX0 delivers leading-edge optical performance with a contemporary design that blends seamlessly into any environment
- Full breadth of area lighting optics including Type 2, Type 3, Type 4, Type 5 and Forward Throw offering superior uniformity and maximum pole spacing
- The D-Series is available with wireless networked embedded controls from nLight®, addressing requirements of Luminaire Level Lighting Controls (LLCC). An nLight AIR sensor is embedded with in this luminaire.
- Multi-pattern mounting built-in for easy installation onto existing mounting holes
- Ideal for pedestrian scale applications including parking lot, area lighting, campuses, bike paths, walkways, and retail sites

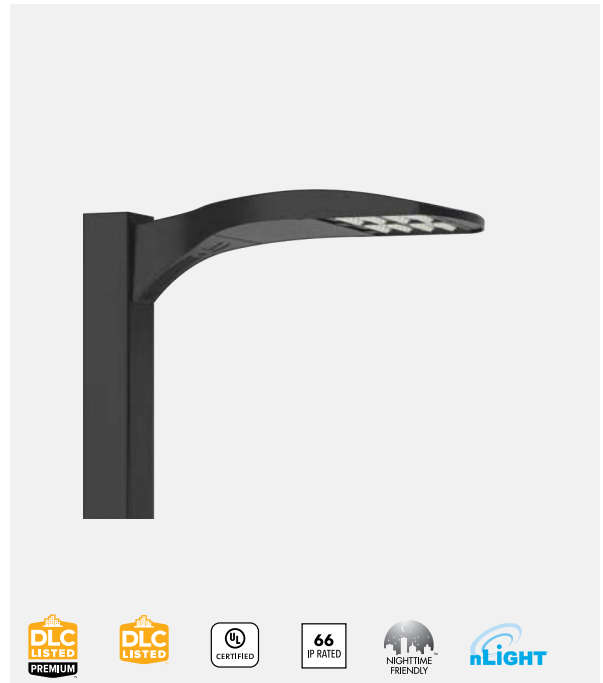

Description

DSX0 LED P4 40K 70CRI T4M MVOLT SPA NLAIR2 PIRHN DDBXD

Prices starting at \$909

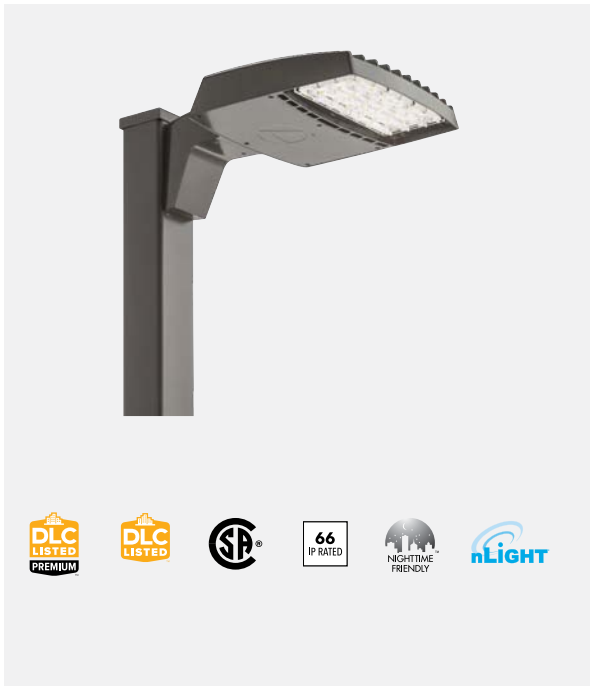

Lithonia Lighting®

RSX1

LED Area Luminaire

- With up to 17,000 lumens, the RSX1 can replace 70W to 400W metal halide luminaires. Ideal for new construction, renovation, and one-for-one replacement when availability, price and payback are of utmost importance
- Full breadth of area lighting optics including Type 2, Type 3, Type 4 and Type 5 photometric distributions offering superior uniformity
- Easy to install standard arm for round or square pole featuring a universal, no-drill mounting. Additional mountings available including wall bracket and adjustable slipfitter
- Super-efficient LED's featuring excellent LPW. Energy savings up to 75%+ can be achieved when replacing HID
- Ideal for pedestrian, parking lot and area lighting applications including retail, education, parks/recreation, warehouse and office

Description
 RSX1 LED P4 40K R4 MVOLT SPA NLTAIR2 PIRHN DDBXD
 Target - \$403

Lithonia Lighting®

RSX2

LED Area Luminaire

- With up to 31,000 lumens, the RSX2 can replace up to 400W metal halide luminaires. Ideal for new construction, renovation, and one-for-one replacement when availability, price and payback are of utmost importance
- Full breadth of area lighting optics including Type 2, Type 3, Type 4 and Type 5 photometric distributions offering superior uniformity
- Easy to install standard arm for round or square pole featuring a universal, no-drill mounting. Additional mountings available including wall bracket and adjustable slipfitter
- Super-efficient LED's featuring excellent LPW. Energy savings up to 75%+ can be achieved when replacing HID
- Ideal for pedestrian, parking lot and area lighting applications including retail, education, parks/recreation, warehouse and office.

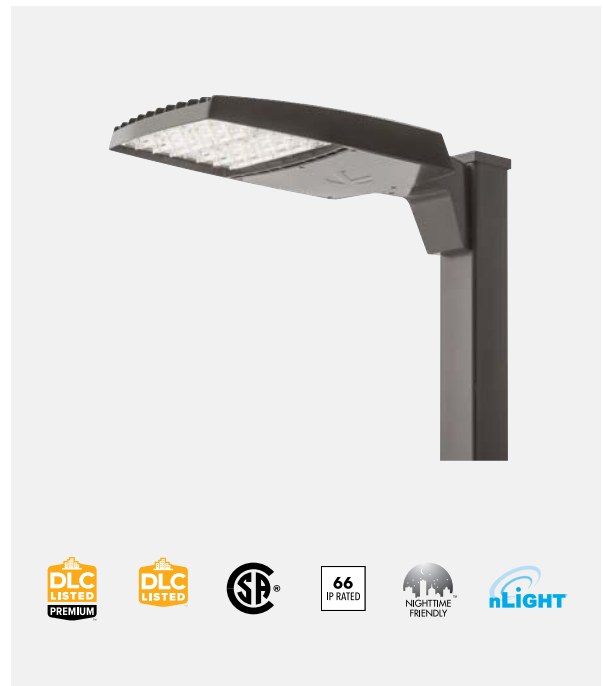

Description
 RSX2 LED P4 40K R4 MVOLT SPA NLTAIR2 PIRHN DDBXD
 Prices starting at \$738

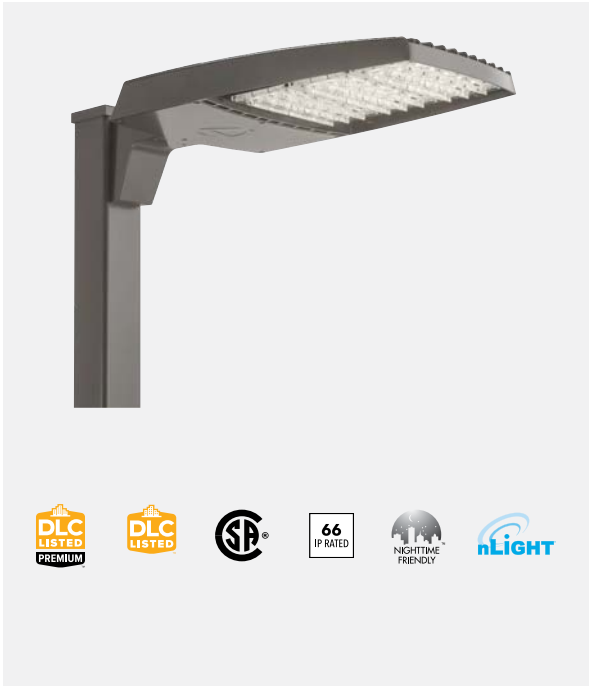

Lithonia Lighting®

RSX3

LED Area Luminaire

- With up to 41,000 lumens, the RSX3 can replace 1000W metal halide luminaires. Ideal for new construction, renovation, and one-for-one replacement when availability, price and payback are of utmost importance
- Full breadth of area lighting optics including Type 2, Type 3, Type 4 and Type 5 photometric distributions offering superior uniformity
- Easy to install standard arm for round or square pole featuring a universal, no-drill mounting. Additional mountings available including wall bracket and adjustable slipfitter
- Super-efficient LED's featuring excellent LPW. Energy savings up to 75%+ can be achieved when replacing HID
- Ideal for pedestrian, parking lot and area lighting applications including retail, education, parks/recreation, warehouse and office

Description

RSX3 LED P4 40K R4 MVOLT SPA NLTAIR2 PIRHN DDBXD
Prices starting at \$947

Lithonia Lighting®

RSX4

LED Area Luminaire

- With up to 70,000 lumens, the RSX4 can replace up to two 1000W metal halide luminaires. Ideal for new construction, renovation, and one-for-one replacement when availability, price and payback are of utmost importance
- Full breadth of area lighting optics including Type 2, Type 3, Type 4 and Type 5 photometric distributions offering superior uniformity
- Easy to install standard arm for round or square pole featuring a universal, no-drill mounting. Additional mountings available including wall bracket and adjustable slipfitter
- Super-efficient LED's featuring excellent LPW. Energy savings up to 75%+ can be achieved when replacing HID
- Ideal for pedestrian, parking lot and area lighting applications including retail, education, parks/recreation, warehouse and office

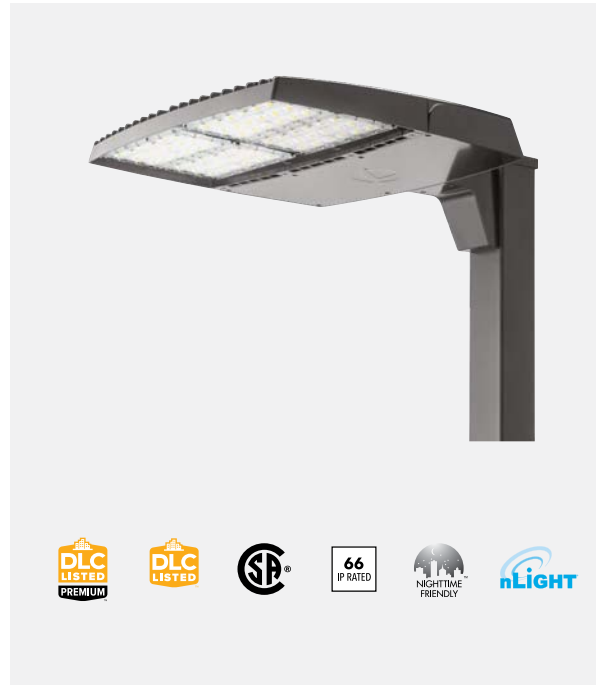

Description

RSX4 LED P4 40K R4 MVOLT SPA NLTAIR2 PIRHN DDBXD
Prices starting at \$1372

Lithonia Lighting®

RSXF1

LED Floodlight

- With up to 23,000 lumens, the RSXF1 can replace 400W metal halide floodlights. Ideal for new construction, renovation, and one-for-one replacement when availability, price and payback are of utmost importance
- Most popular wide and area forward floodlighting distribution patterns offering superior uniformity
- Easy to install adjustable slipfitter mounts onto 2 3/8" OD tenon; yoke mount also available
- Super-efficient LED's featuring excellent LPW. Energy savings up to 60%+ can be achieved when replacing HID
- Ideal for area and flood lighting applications including retail, education, parks/recreation, warehouse and office



Description

RSXF1 LED P3 40K AWFD MVOLT IS DDBXD

Prices starting at \$477

Lithonia Lighting®

RSXF2

LED Floodlight

- With up to 44,000 lumens, the RSXF2 can replace 250W to 1000W metal halide luminaires. Ideal for new construction, renovation, and one-for-one replacement when availability, price and payback are of utmost importance
- Most popular wide and area forward floodlighting distribution patterns offering superior uniformity
- Easy to install adjustable slipfitter mounts onto 2 3/8" OD tenon; yoke mount also available
- Super-efficient LED's featuring excellent LPW. Energy savings up to 75%+ can be achieved when replacing HID
- Ideal for area and flood lighting applications including retail, education, parks/recreation, warehouse and office

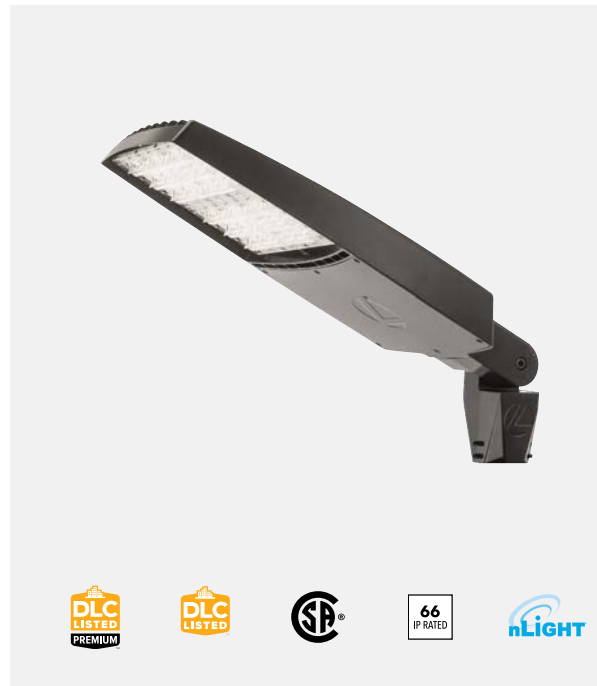

Description

RSXF2 LED P3 40K AWFD MVOLT IS DDBXD

Prices starting at \$647

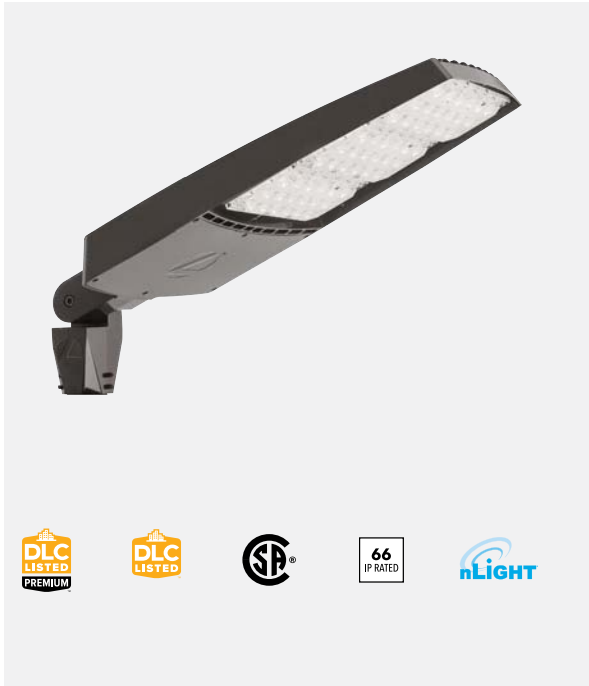

Lithonia Lighting®

RSXF3

LED Floodlight

- With up to 41,000 lumens, the RSXF3 can replace 1000W metal halide luminaires. Ideal for new construction, renovation, and one-for-one replacement when availability, price and payback are of utmost importance
- Most popular wide and area forward floodlighting distribution patterns offering superior uniformity
- Easy to install adjustable slipfitter mounts onto 2 3/8" OD tenon; yoke mount also available
- Super-efficient LED's featuring excellent LPW. Energy savings up to 71%+ can be achieved when replacing HID
- Ideal for area and flood lighting applications including retail, education, parks/recreation, warehouse and office

Description

RSXF3 LED P3 40K AWFD MVOLT IS DDBXD

Prices starting at \$824

Lithonia Lighting®

RSXF4

LED Floodlight

- With up to 85,000 lumens, the RSXF4 can replace 1000W or 1500W metal halide luminaires. Ideal for new construction, renovation, and one-for-one replacement when availability, price and payback are of utmost importance
- Most popular wide and area forward floodlighting distribution patterns offering superior uniformity
- Easy to install adjustable slipfitter mounts onto 2 3/8" OD tenon; yoke mount also available
- Super-efficient LED's featuring excellent LPW. Energy savings up to 60%+ can be achieved when replacing HID
- Ideal for area and flood lighting applications including retail, education, parks/recreation, warehouse and office



Description









RSXF4 LED P3 40K AWFD MVOLT IS DDBXD

Prices starting at \$1272

Eureka QuickShip Price Guide

QTY 5 or under ship in 5 Business Days, QTY 20 or under ship in 10 Business Days

Fixture/ Link	Image	Starting at
<p>Pricing Subject to Change.</p>		
<p>VERNER 4273-14</p>		<p>\$753</p>
<p>SCOUT MME Program</p>		<p>\$347</p>
<p>MIKA MME Program</p>		<p>\$510</p>
<p>APERTURE (multiple QS SKUs available)</p>		<p>\$1074</p>
<p>MUTE (multiple QS SKUs available)</p>		<p>\$853</p>
<p>VALCO 4259</p>		<p>\$1217</p>

TWIN (multiple QS SKUs available)		\$795
BLOOM MME Program		\$672
TUMBLER 3409 MME Program		\$418
MOONRISE CLASSIC 3530-23		\$365
CYCLE (multiple QS SKUs available)		\$1991
CYCLE ACOUSTIC (multiple QS SKUs available)		\$2095
STELLA 4272DI-9		\$708
Quadrant (multiple QS SKUs available)		\$1647

Quadrant Unlit Version (multiple QS SKUs available)		\$191
Mill Pendant Mount MME Program		\$478
Mill Surface Mount (multiple QS SKUs available)		\$797
Mill Unlit Pendant/ Surface (multiple QS SKUs)		\$369
Area Pendant (multiple QS SKUs available)		\$1126
Area Surface Mount (multiple QS SKUs available)		\$1076
Area Acoustic- Pendant (multiple QS SKUs)		\$500
Area Acoustic Surface/ Wall (multiple QS SKUs)		\$500