

Client:

Project:

Type:

Order Code:

Quantity:

The **AL Graze DC DMX** is a mid-range output, low profile, outdoor linear LED fixture. Available in 1' and 4' sections, it offers multiple configurations, including RGB, RGBW, and Dynamic White. Featuring a robust IP66 housing, on-board DMX driver with RDM addressing, and linkable cable system, it is the perfect option for any structure that calls for indoor or outdoor linear grazing.

Specifications

Color	RGB, RGBW, RGBA, Dynamic White (2200K-5000K), 2700K, 3000K, 3500K, 4000K
Beam Angle	10° x 60°, 30° x 60°, 15° x 15°, 60° x 60°
Max Fixtures In Series	12'
Total Lumens	419 per foot (4000K, 30° x 60°)
Control	DMX + RDM
Mounting	30° Swivel Mount and Fixed Flat Mount Included
Power Consumption	9W (1'), 36W (4')
Operating Voltage	24VDC
Lumen Maintenance	L70 @ 150,000 Hours (25° C)
Finish	Anodized Brushed Aluminum
Housing Material	Aluminum; Glass Top Lens
Operating Temperature	-4°F to 123°F (-20°C to 50°C)
IP Rating	IP66, Wet or Dry Location
Fixture Connectors	Multipin IP66 Connectors, End to end jumpers attached to each fixture
Warranty	5 Years
Weight	1.25 lbs. / 0.6 kg (1'), 5 lbs / 2.3 kg (4')
Dimensions	L: 12" / 48" W: 1.5" H: 2.3" (L: 305mm / 1220mm W: 38mm H: 59mm)

Certifications



Order Codes

* Indicates Special Order

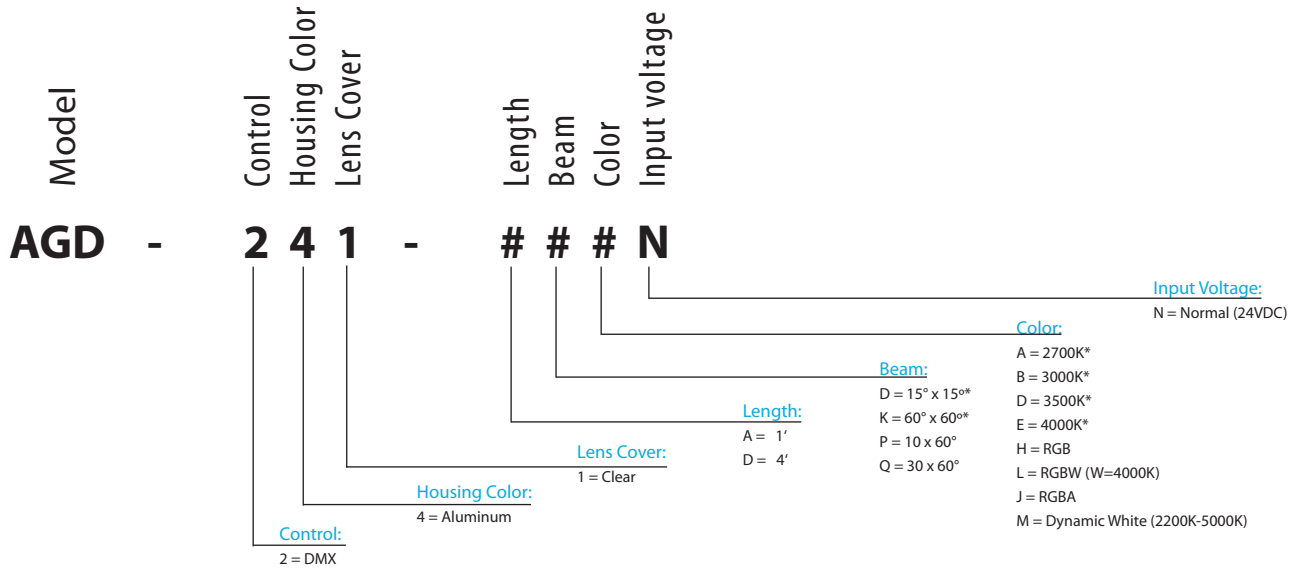

Dimensions

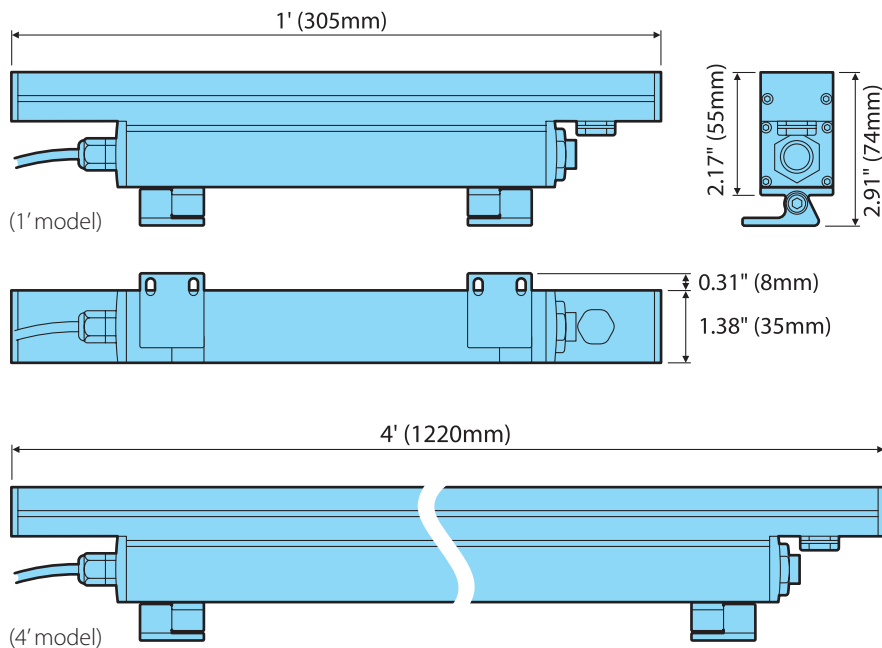

Related Components

Connection Cables

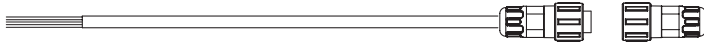

AGDFC10-V2

10' Feed Cable For AL Graze DC DMX + End Cap

Powers up to 12'



AGDLC1-V2

1' Link Cable for AL Graze DC DMX

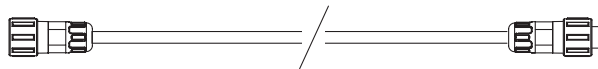

AGDLC5-V2

5' Link Cable for AL Graze DC DMX

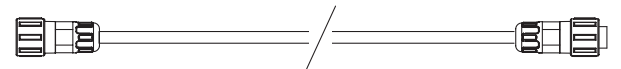

AGDLC10-V2

10' Link Cable for AL Graze DC DMX



AGDEC-V2

End Cap for AL Graze DC DMX

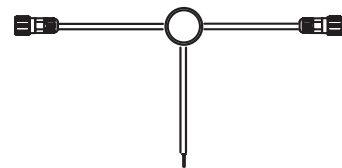

AGDT1-V2

1' DMX "T" Jumper for AL Graze DC DMX

Power Supplies

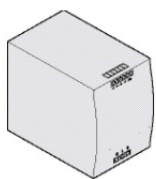

APS-240-24

Powers 2 x 12' Runs

240W, 24VDC, Dry location, DIN Rail Mount
115-230VAC (47-63Hz) Input

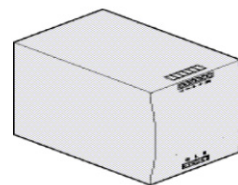

APS-480-24

Powers 4 x 12' Runs

480W, 24VDC, Dry location, DIN Rail Mount
115-230VAC (47-63Hz) Input

Glare Shields



AGS1

12" Single Sided Glare Shield for AL Graze DC



AGS4

48" Single Sided Glare Shield for AL Graze DC

Related Components (Con't)

Louvers

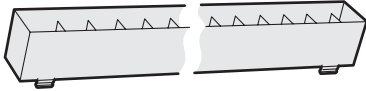

AGLV12
12" Louver for AL Graze DC DMX

AGLV48
48" Louver for AL Graze DC DMX

Extender Bars

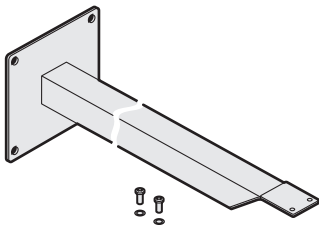

AGEB12
12" Extender Bar for AL Graze DC DMX

AGEB24
24" Extender Bar for AL Graze DC DMX

Mounting Accessories

AG90
90 Degree Mounting Bracket for AL Graze DC DMX

Fixture Setup Accessories

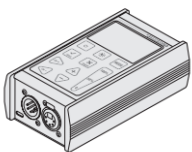

XMT350
DMX + RDM Addressing and Testing Tool

Photometrics

For additional color data and IES files, please visit acclaimlighting.com

RGB 10° x 60° 1'

Zonal Lumen Summary

Zone	Lumens	%
0-60	233.9	99.2
60-90	1.8	0.7
90-180	0.1	0.0
Total	235.7	100

Polar Candela Distribution

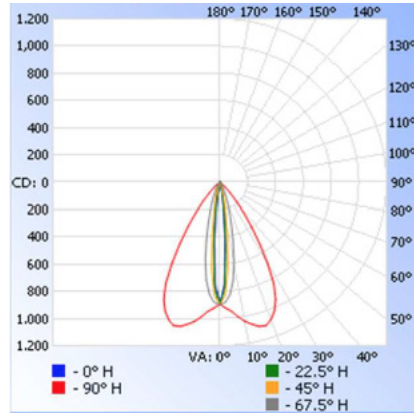

Isofootcandle Plot

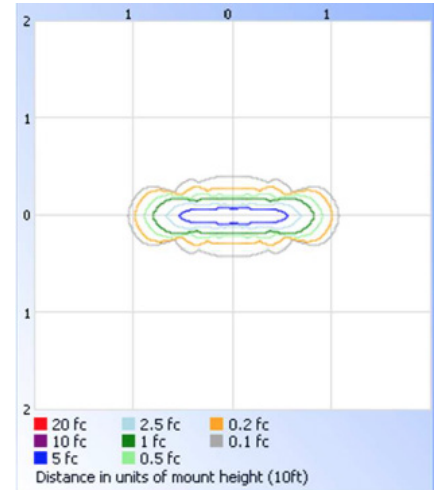

4000K 30° x 60° 1'

Zonal Lumen Summary

Zone	Lumens	%
0-60	404.7	98.8
60-90	5.0	1.2
90-180	0.0	0.0
Total	419.7	100

Polar Candela Distribution

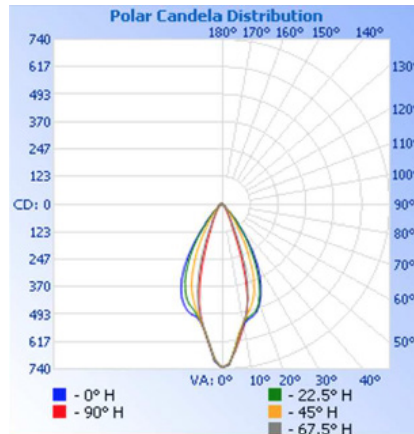

Isofootcandle Plot

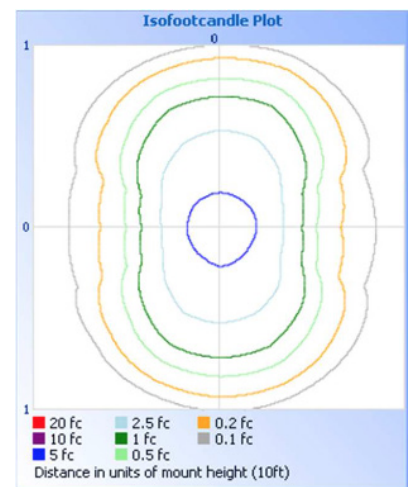

Wiring

