

# RADAR

surface LED downlight with optional accent uplight



### CONSTRUCTION

- Anodized satin aluminum driver canopy and reflector.
- Integral drivers accessible through fixture, including when mounted to conduit.
- **RGBW** is remote install only. Optional DMX wall box also available. Order **BDMXCON** separately. (See p. 2.)
- Optional accent uplight: Lens is clear acrylic, with frosted edge.
- Downlight LED engine is white or color-tuning **CT**. Uplight is white or **RGBW**. Downlight and accent light are separate-switched.
- Drivers are universal voltage (120–277V).
- Reflector interior is anodized, specular, durable and anti-iridescent. 30° cutoff (.30). Finish is Clear Alzak® Haze.
- cUL listed for dry and damp locations only (pending).

<b>TYPE:</b>	<b>PROJECT:</b>
<b>ORDER NUMBER:</b>	

MODEL#	LUMENS DOWN (White LEDs only)	LEDs DOWN	LEDs UP	FINISHES	DIMMING	MOUNT OPTION	OPTION
<b>IL7600</b>	<b>LO</b> –2,000 <b>MO</b> –3,000 <b>HO</b> –4,000	<b>W30</b> <b>W35</b> <b>W40</b> <b>CT</b> –Color Tuning	<b>W30</b> <b>W35</b> <b>W40</b> <b>RGBW</b> –color + 3500° K white	<b>SA</b> –Satin Aluminum	<b>D</b> –Standard <b>BDIM-W11</b> <b>DA</b> –DALI <b>DMX</b> <b>DPH</b> –Phase	<b>CM2</b> –pipe mount <b>BLA</b> –ball aligner <b>RC0</b> <b>RC1</b> <b>RC2</b> <b>RC3</b>	<b>EM</b> –Emergency <b>RR</b> –Remote Driver
Example:							
<b>IL7600</b>	<b>HO</b>	<b>W35</b>	<b>B</b>	<b>SA</b>	<b>D</b>	<b>CM2</b>	<b>EM</b>

<b>XL</b> –custom lumen reduction (specify lumens, downlight only):	Specify <b>CM2</b> pipe length (inches):
<b>BDMXCON-W</b> –white faceplate (enter quantity):	<b>BDMXCON-B</b> –black faceplate (enter quantity):

### CONDUIT CONFIGURATIONS (specify one of three, below)

**RC1** – one conduit feed for dead end or single fixture.

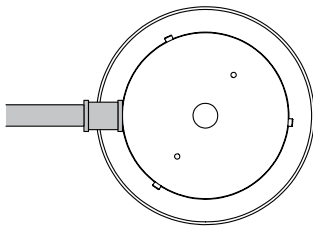

**RC2** – two feeds 180° opposite, for straight runs.

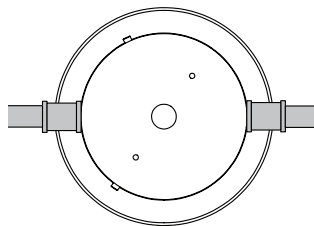

**RC3** – two feeds for 90° wire turns.

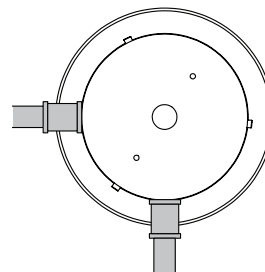

### RCO – SURFACE MOUNT

Driver canopy and wireway mounts directly to ceiling.

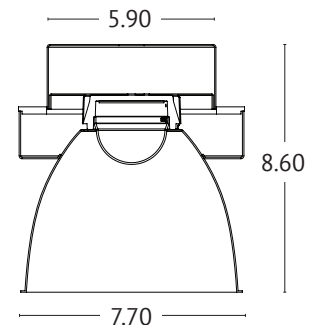

### EMERGENCY

Specify **EM**. Battery pack provides 10W for 90 minutes. Mounted remote, with test switch and charge indicator light. Accessible through remote box door.

*Voltage must be specified.*

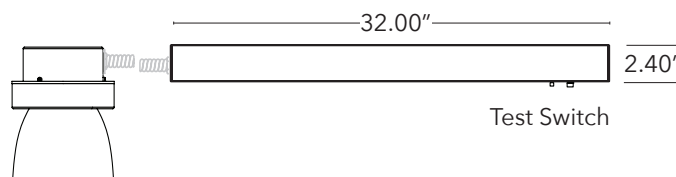

# RADAR

surface LED downlight with optional accent uplight



## WHITE LEDS

LED modules feature opal diffuser that provide the appearance on an A-lamp from below. Specify color: **W30**–3000°, **W35**–3500°, or **W40**–4000° Kelvin. CRI = 92, R9 = 72.

## CUSTOM LUMEN OUTPUT REDUCTION

Factory set custom reduced-lumen output driver configuration. Specify lumens.

## COLOR LEDS

Uplight is **RGBW** with 3500°K white LEDs. **CT** downlight uses Lumenetix-araya™ Entertainment LED module 1650-8000°K white tunable range, 90+ CRI, with red, green, blue, amber, mint, and cyan chips. See <https://www.erp-power.com/our-products/tunable-color-lumenetix-araya/> for details. Includes dimming interface. Optional DMX controller also available (See below.)

## DIMMING

- **D**–standard supplied driver. 0–10V, programmable, 1% dimming, 120/277V, 50/60 Hz.
- **BDIM-W11**–Lutron EcoSystem LED14 Series, 1% dimming, fade-to-off.
- **DPH**–Triac and ELV 1% dimming at 120V 60 Hz only.
- **DA**–DALI 1% dimming, fade-to-off. 120/277V, 50/60 Hz.
- **DMX**–for both white and RGBW LEDs, 0.1% dimming fade-to-off. 120/277V 50/60Hz

## EMERGENCY

Emergency Battery Pack provides 10W for 90 minutes. Mounted remote, with test switch and charge indicator light. Accessible through remote box door. Order **EM**. Voltage must be specified.

## WATTS / DELIVERED LUMENS

MODEL	WATTS	DELIVERED LUMENS	MODEL	WATTS	DELIVERED LUMENS
<b>IL7600 LO</b> (white)	22	2,000	<b>IL7600 CT</b> downlight	39	N/A
<b>IL7600 MO</b> (white)	33	3,000	<b>IL7600 RGBW</b> uplight	6	N/A
<b>IL7600 HO</b> (white)	44	4,000	<b>IL7600</b> uplight (white)	9	N/A

## DOWNLIGHT CP DISTRIBUTION

22W shown

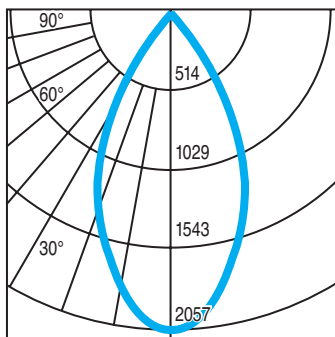

## DOWNLIGHT COEFFICIENTS

22W shown

% CEILING 80 (20% FLOOR)

% WALL	70	50	30
0	119	119	119
1	114	111	109
2	108	103	100
3	103	97	92
4	98	91	85
5	93	85	79
6	89	80	74
7	85	76	70
8	81	72	66
9	77	68	62
10	74	64	59

## REMOTE DRIVERS

For suspended and hard lid ceilings with access panels. Must be accessible after installation. Order **RR**.

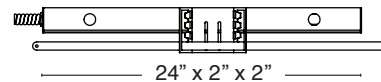

Max. Wiring Distance (at full load)

Wire Size (AWG)	Distance (ft.)
18	18
16	29
14	46
12	71
10	120

**NOTE:** Multiple drivers must be mounted no less than four in. apart side-by-side, and one inch apart end-to-end, to prevent overheating.

## OPTIONAL DMX CONTROLLER

- Standalone, wall-mounted DMX controller for **RGBW/CT** LEDs that provides direct access to fixtures. Power supply included.
  - Tune color hue with sensitive wheel. Saturation and brightness control. On/off switch.
  - See <https://www.nicolaudie.com/en/stick-cw4.htm> for details.
- Order separately, either **BDMXCON-W**–white faceplate or **BDMXCON-B**–black faceplate.

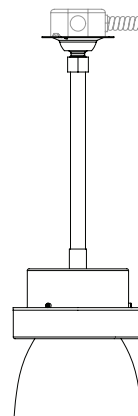

## OPTIONAL PIPE MOUNT

- Order **CM2** – 3/8" ID pipe mount. (**BLA**–Ball Aligner shown.)
- Length must be specified (24" maximum).