

BeveLED® 2.2 Infinite Color+® Cylinder - CBRD10-FC1 Round Downlight



PENDANT WITH FLAT CANOPY



PENDANT WITH CONDUIT CUTOUT



SURFACE MOUNT



usailighting.com/cylinders

Power and beauty are both in play with our sleek architectural cylinders. The BeveLED Cylinder provides industry-leading performance for any ceiling type, with more lumen packages and dimming options than ever before. Now available with Infinite Color+, providing access to a wide variety of perfect architectural whites, saturated colors, neutrals, and pastels are possible with DMX controls. Infinite opportunities abound for residential, hospitality and retail lighting applications, and any project requiring full color and white light flexibility.

FEATURES

- Full color and white light flexibility in a variety of standard or custom colors
- Surface mount design conceals mounting hardware and provides seamless finish to ceiling plane
- Rigid pendant stem with 30° hang straight feature and aircraft cable mount options
- Convenient conduit cutout canopy mounting option for attachment to surface-mounted junction boxes and conduit

DOWNLIGHT PERFORMANCE DATA

DELIVERED PERFORMANCE:	Infinite Color +	
	White Light Channel Only	Multi Channel Output
Wattage	23W	32W
Source Lumens:	1675	2100
Lumens Per Watt:	62	55
Delivered Lumens:	1400	1750

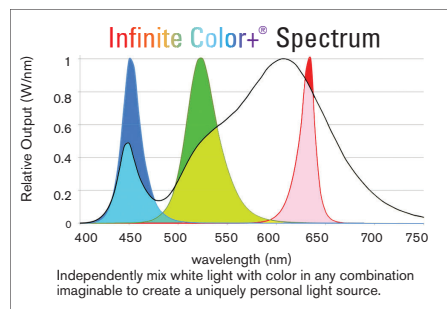

HOW TO SPECIFY

BeveLED® 2.2 Infinite Color+® Cylinder - CBRD10-FC1 Round Downlight with Integral Driver



Specify fixture part number. All boxes must be filled in to correctly order.

INTEGRAL DRIVER ORDERING INFORMATION

CBRD10	32FC1		SF			UNV		DW
BeveLED Cylinder	Wattage Options	Beam Options	Lens Options	Finish Options	Mounting Options	Voltage Options	Dimming Driver Options	Cabling Options
CBRD10 BeveLED Cylinder Round Downlight 10" Length	32FC1 32W LED	70 70° beam 90 90° beam	SF Solite Frosted	WH White SC Conduit Silver GR Grey BL Black BZ Bronze SN Satin Nickel RAL Custom Color	SM Surface Mount Rigid Stem Mount + Recessed JBox Canopy Style PR1 24" field cuttable Rigid Stem Mount + Conduit Cutout Canopy Style PJ1 24" field cuttable	UNV 120V - 277V	D23X1 EldoLED DMX 0.1% dimming, manual addressing using RDM protocol, 8 bit D23X2 EldoLED DMX 0.1% dimming, manual addressing using RDM protocol, 16 bit	DW Wire leads provided for integral driver

PENDANT STEM ACCESSORY (required for PJ and PR mount only)

Pendant Stem Type	Stem Length	Stem Finish
PXB Pendant Mount 5/8" Diameter	24 24" Stem Lengths Field Cuttable	WH White SC Conduit Silver GR Grey BL Black BZ Bronze SN Satin Nickel RAL Custom Color

TRIM FINISH OPTIONS

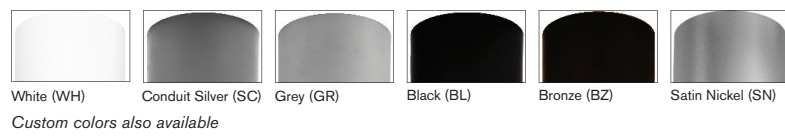

BeveLED® 2.2 Infinite Color+® Cylinder - CBRD10-FC1 Round Downlight



DIMENSIONS

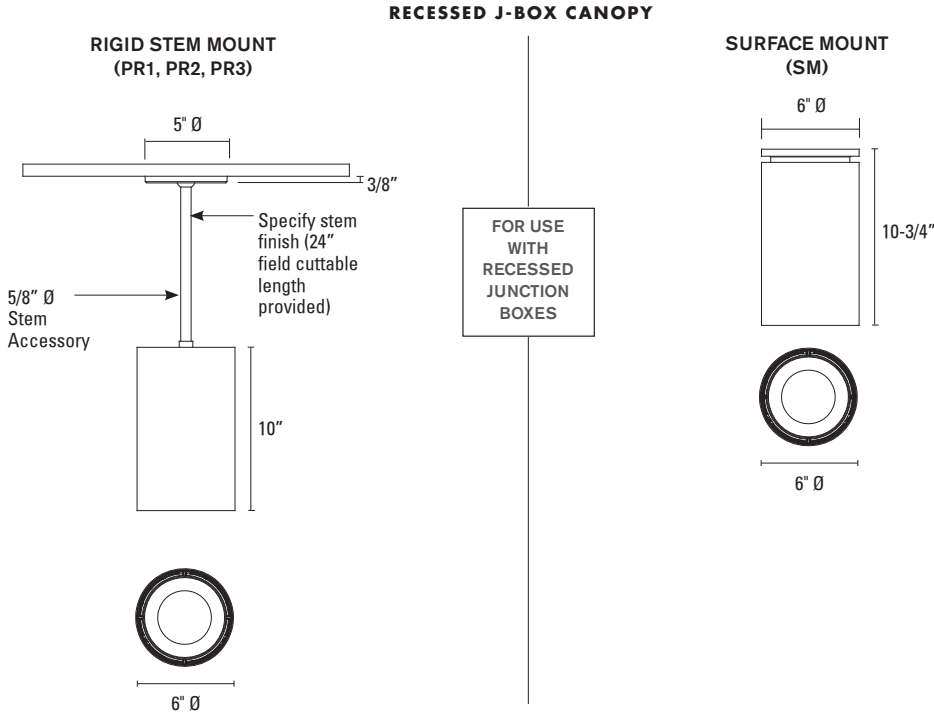

CONDUIT CUTOUT CANOPY FOR SURFACE MOUNTED J-BOX

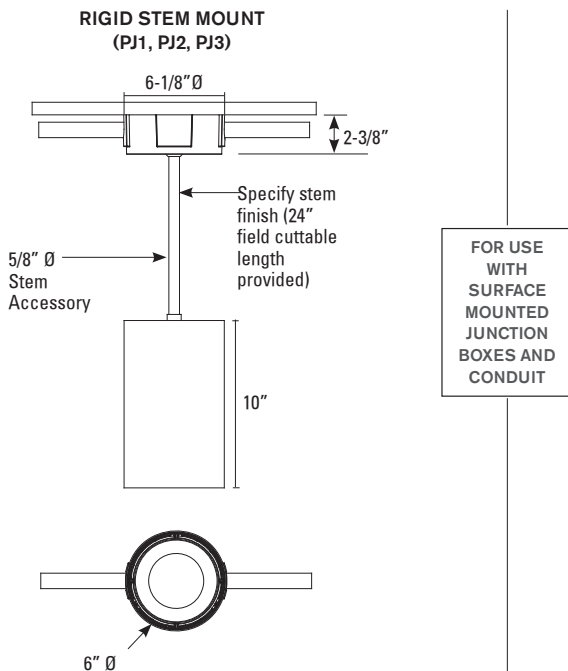

	Project 21-12877-3 Date 6/25/2021 RGB/W Saturated Color	Catalog Number RPB-01 18FC1 UNV D23X2 RJ	Type
	Submitted By 16500, INC	Notes	

BeveLED® 2.2 Infinite Color+® Cylinder - CBRD10-FC1 Round Downlight



BEVELED 2.2 CYLINDER INFINITE COLOR+ SPECIFICATIONS

FIELD REPLACEABLE LED LIGHT ENGINE

Light engine is serviceable without tools. All USAI Lighting light engines feature industry-leading color consistency.

FIELD REPLACEABLE INTEGRAL DRIVER

Solid state electronic constant current DMX512 driver with a high power factor provided standard. Works with universal voltages 120V-277V. All integral dimming drivers are located within the cylinder body and are serviceable from below the ceiling. Driver complies with IEEE C62.41 surge protection. Specify D23X1 for 8-bit communication controls; specify D23X2 for 16-bit communication controls. All driver options require remote device management (RDM) communication protocol for addressing.

CABLING: Data cables must be run in series between fixtures. Integral driver fixtures require manual wire splices for data cables. To avoid signal transmission problems, a DMX link terminator device should be used in the last fixture in a series on a given DMX bus. NOTE: Data communication cables and AC power lines must not be run in the same conduit.

• **Integral Driver and Remote Power Supply DW Cabling Option:** The fixture is provided with DMX lead wires to be manually spliced for data connection. NOTE: DMX link termination device (by others) should be used on the last fixture in line on a circuit to avoid signal loss. The data cable used must meet the following requirements:

- type: shielded, 2-conductor twisted pair
- maximum capacitance between conductors: 30 pF/ft
- maximum capacitance between conductor and shield: 55 pF/ft
- maximum resistance: 0.02 ohms/ft
- normal impedance: 100-140 ohms
- conductive core: 24 AWG is recommended

If 3-wire data cables are preferred, we suggest a Belden 9841 or equivalent cable which meets the specifications for EIA RS-485 applications. Do not use standard microphone cables: they cannot transmit DMX512 data reliably over long distances. NOTE: DMX link termination device (by others) should be used on the last fixture in line on a circuit to avoid signal loss.

BODY

6"Ø extruded aluminum body available in a variety of powder coated paint finishes or an anodized satin nickel finish. Custom colors also available (provide RAL #).

FRONT CAP

Standard cylinder is provided with snap in diecast 1" regressed bevel assembly in finish specified. Standard front cap retains a solite frosted glass lens.

MOUNTING OPTIONS

In all cases hardware included for mounting to 4" octagonal junction box.

SURFACE MOUNT

If the "SM" mounting option is specified, cylinder is provided with a 6" Ø x 1/2" deep round canopy that allows for completely tool-less mounting to a recessed junction box with no visible hardware.

FIELD CUTTABLE RIGID PENDANT STEM MOUNT

5/8" Ø (3/8" IPS) steel stem is provided in a 24" length with 30° hang straight. Specify stem finish in accessories table when ordering; stem is field cuttable to a minimum length of 6".

RECESSED JBOX CANOPY:

If recessed J-box canopy style (PR1) canopy is specified, 5" Ø x 3/8" deep canopy is provided for mounting to recessed mounted junction box. Recessed jbox canopy is provided in matching finish per fixture body finish specification.

CONDUIT CUTOUT CANOPY:

If surface mounted j-box canopy style (PJ1) is specified, 5-13/16" Ø round x 2-3/8" deep canopy is provided for mounting to standard 4" x 1-1/2" octagonal surface mounted junction box. Conduit cutout canopy has 4 keyslots, one in each side, and ships with three conduit cutout keys and three solid cover keys which are field interchangeable and can be configured to accommodate any ceiling layout using 1/2" or 3/4" conduit. Conduit cutout canopy is provided in matching finish per fixture body finish specification.

BeveLED® 2.2 Infinite Color+® Cylinder - CBRD10-FC1 Round Downlight



BEVELED 2.2 CYLINDER INFINITE COLOR+ SPECIFICATIONS (continued)

CONDUIT CUTOUT MOUNTING EXAMPLE

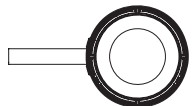

Conduit End



Straight Conduit

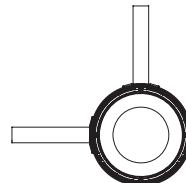

L Conduit

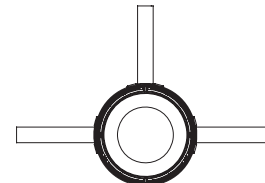

T Conduit

4" OCTAGONAL JUNCTION BOX DETAIL

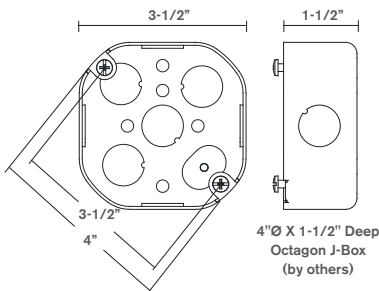

KEY COVER DETAIL

SOLID COVER KEY

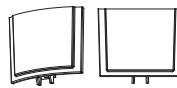

3 provided with each Conduit Cutout Canopy

CONDUIT CUTOUT KEY

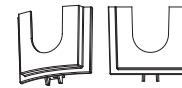

3 provided with each Conduit Cutout Canopy

FIXTURE WEIGHT

Cylinder weighs 8 lbs (not including rigid pendant stem accessory).

WARRANTY

Based on IESNA LM80-2008, BeveLED Cylinder has a 50,000 hour rated life at 70% lumen maintenance (L70). USAI Lighting Warranty covers replacement parts for 5 years from date of shipment.

LISTINGS

Dry/Damp/Wet for SM and PR1 mounting only. PJ1 is Dry/Damp only. NRTL/CSA-US tested to UL standards. IBEW union made.



NOTES

- Ambient temperatures at fixture location should not exceed 40°C during normal operation.
- For interior use only
- Consult factory for video capture applications.

PHOTOMETRICS

Consult factory or website for IES files. Tested in accordance with IESNA LM79-2008.

BeveLED[®] Infinite Color+[™]

DIMMING DRIVER COMPATIBILITY SELECTION GUIDE D23X1, D23X2

DIMMING DRIVER WIRING SCHEMES:

IMPORTANT SAFETY INSTRUCTIONS

SAVE THESE INSTRUCTIONS

1. Keep these instructions in a safe place for future reference.
2. Only qualified electricians in accordance to local codes should install these fixtures.
3. De-energize the electrical circuit at the circuit breaker prior to installation process or servicing.
4. Make sure all connections are in accordance with the National Electrical Code and any local regulations.

D23X1: EldoLED DMX dimming with manual addressing, 8-bit (Dims down to 0%)

D23X2: EldoLED DMX dimming with manual addressing, 16-bit (Dims down to 0%)

DW CABLING OPTION - DMX SIGNAL WIRE LEADS

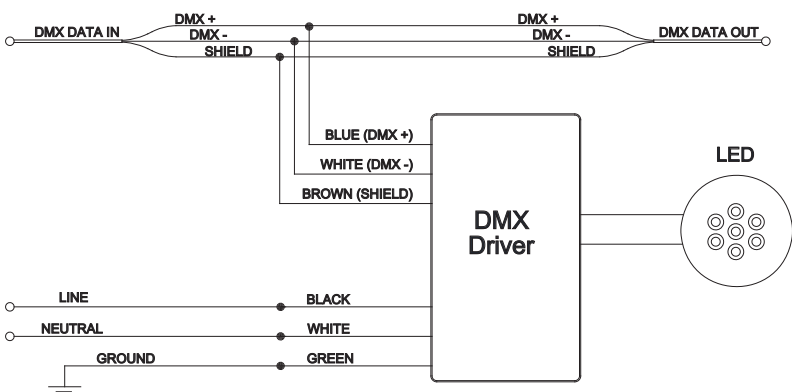

•DW Cabling Option: no interface board is supplied; cables must be specified inside the junction box for connection. The data cable used must meet the following requirements:

- type: shielded 2-conductor twisted pair
- maximum capacitance between conductors: 30 µF/ft
- maximum capacitance between conductor and shield: 55 µF/ft
- maximum resistance: 0.02 ohms/ft
- normal impedance: 100-140 ohms
- conductive core: 24 AWG is recommended

If 3-wire data cables are preferred, we suggest a Belden 9841 or equivalent cable which meets the specifications for EIA RS-485 applications. Do not use standard microphone cables as they cannot transmit DMX512 data reliably over long distances. NOTE: DMX link termination device (by others) should be used on the last fixture in line on a circuit to avoid signal loss.

DMX MUST BE DAISY CHAINED IN SINGLE LINE

CORRECT !

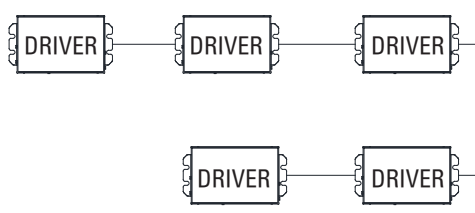

INCORRECT !

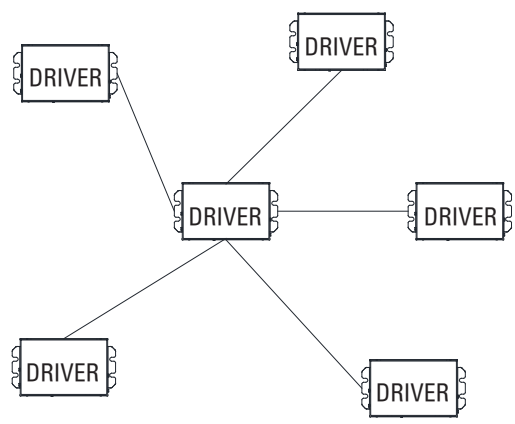

NOTES FOR DRIVERS:

1. DMX signal cable must NOT be run in same conduit as high voltage AC power lines.
2. Fixtures must be daisy chained in one serial line
3. Maximum of 32 DMX devices on a single DMX bus
4. Maximum of 1600 ft serial communication link distance
5. To avoid signal loss, DMX signal terminator should be used on last fixture in line. For DW cabling options, this device (120 ohm resistor) is provided by others.
6. For best results use communication data splices.