



Purelight LED  
Round My White



Order Code: PL9LR - 1A32 - TW - SD - \_\_\_\_\_ - \_\_\_\_\_ - \_\_\_\_\_ - \_\_\_\_\_ - \_\_\_\_\_ - \_\_\_\_\_ - \_\_\_\_\_

Series	PL9LR Purelight LED Round					
Light Engine	1A32 <sup>1</sup> 500lm/8.1W per foot					<sup>1</sup> Average values calculated from a 4' fixture with CLL using DMX driver. For additional information please see page 2.
CCT	TW Tunable White - 2700K through 6500K 90+ CRI					
Shielding	SD Satine lens					
Mounting	C Cable	F Surface Mount (wall/ceiling)				
Nominal Fixture Length	02 2 ft.	03 3 ft.	04 4 ft.	06 6 ft.	08 8 ft.	RUN <sup>2</sup> Runs available in nominal 4' lengths  <sup>2</sup> Runs only available with Cable Mount. Consult factory for Surface Mount Runs.
Finish	WH White	BL Semi-Matte Black	SV Silver	PO <sup>3</sup> Polished Clear Coated	SP Specify Premium Color	<sup>3</sup> Custom colors are available, Please consult factory  *back rail finish to match end cap finish except for PO. For PO endcaps, back rail standard finish will be white
Voltage	120 120V	277 27V	UNV 120V through 277V 50/60hz capable			
Driver	DMW <sup>4</sup> eldoLED 1% DUALdrive DALI (Linear)	DMX <sup>4,5</sup> eldoLED POWERdrive DMX (Linear)	DLL <sup>4</sup> eldoLED DALI (Logarithmic) Dimming (Linear) CCT balance	DTW <sup>4</sup> eldoLED SOLOdrive 0-10V LightShape(Linear)	DMT Lutron T-Series for Athena or Quantum Controls only (consult factory)	<sup>4</sup> See page 5 for full details <sup>5</sup> Consult factory for addressing of drivers
Fixture Options	DL <sup>6</sup> Damp Location Rated	FS <sup>6</sup> In-line Fuse	SS <sup>6</sup> Separate Switching	WC <sup>7</sup> Wall Controller Connections	<sup>6</sup> See page 7 for details <sup>7</sup> For use with DMX only. See page 2 for details.	
Emergency Options	EC <sup>8</sup> Emergency Circuit Wiring	EMR <sup>9</sup> Remote Battery Pack				<sup>8</sup> See page 6 for full details <sup>9</sup> Consult factory

Purelight LED - Round My White

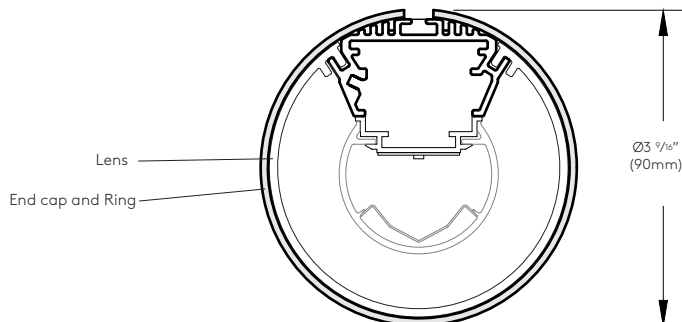

**Construction:**

**Housing** - White powder coated, low copper 6063-T6 extruded aluminum profile available as Individual fixtures (up to 8') or Runs in 4' increments.

**Geartray** - Low copper 6063-T6 extruded aluminum profile.

**Shielding** - Round Satine lens with diffusion optics provides luminous lines of diffuse light. Lens made from impact resistant PMMA (acrylic).

**End Cap** - Die cast aluminum end cap, powder coated or polished, clear coated, designed for toolless access to the geartray (except surface mounting).

**Mounting(s)** - 1/16" Aircraft Cable (48" maximum from ceiling to top of fixture), Surface mounting (wall or ceiling).

\*\*Cables are adjustable for individual fixtures, however Cable and Wall mountings may not be symmetrical for Runs due to the use of modular housing lengths. If symmetrical suspensions are required please consult the factory.

**Standard Luminaire lengths** - All standard luminaires are supplied in nominal lengths to ensure full, even, illumination.

\*\*Individual luminaires are not joinable in the field.

**Runs** - Runs (over 8') are available in 1' increments (made up of 3' and 4' sections) for cable mount fixtures. There will be a joiner ring every 3' or 4' depending on the length. Cables are fixed to rings. For Runs with wall or surface mount, consult factory.

**Weight** - 1.8 lbs. per ft.

**Electrical/Performance:**

**Constant Lumen Level (CLL) Curve** - Selux recommends utilizing the Constant Lumen Level (CLL) curve for the My White product. This is achieved using an algorithm programmed into the controls for driving the two channels of the driver simultaneously so that while adjusting the CCT, the lumen output remains the same. For recommended controls for CLL, please consult Selux.

**LED Light Engine** - Brand-name mid-power LEDs create a high efficiency LED light engine with a reported luminous flux maintenance at 60,000 hours of 86% based on LM-80 test reports. The rated lumen maintenance life is L70 (10k) > 60,000 hours. Luminous flux values calculated in accordance to TM-21 procedures based on LM-80 compliant reported measurement data. For Title 24 compliant model numbers, please consult factory.

**Photometrics** - Consult website or factory for IES Files. Photometric lumen measurement complies with IES LM-79-08 testing procedures. Due to the LED manufacturer's tolerances, the listed output has a ±5% tolerance.

**CCT** - Tunable CCT from 2700K through 6500K tolerance within a 3-step MacAdam ellipse.

**CRI** - 90+.

**Drivers** - High efficiency, constant current, soft start, Electronic Class 2 with a PFC>0.90. For more detailed information on the available drivers please see page 5.

**Wall Controller** - Optional wall controller can be ordered for use with DMX fixtures. See DMX controller spec sheet for more details.

**Thermal Performance:**

**Ambient Operating Temperature** - Luminaires suitable for maximum ambient temperature of 35°C (95°F) for all drivers, standard and optional.

**Luminaire Finish:**

**Powder Coat** - All Selux luminaires are finished in high quality polyester powder coating in our Tiger Drylac certified facility and are tested in accordance with test specifications for coatings from ASTM and PCI.

All products undergo a five stage intensive pretreatment process where product is thoroughly cleaned, phosphated, and sealed. Selux powder coated products provide excellent salt and humidity resistance as well as ultraviolet resistance for color retention.

Standard interior color for Purelight LED is White (WH), Semi-Matte Black (BL), and Silver (SV). Polished clear coated (PO) or Selux premium colors (SP) for endcap finish are available, please specify from your Selux color selection guide.

**Warranty:**

**5 Year Limited LED Luminaire Warranty** - Selux offers a 5 Year Limited Warranty to the original purchaser that the Purelight LED My White luminaire shall be free from defects in material and workmanship for up to five (5) years from date of shipment. This limited warranty covers the LED driver and LED light engine when installed according to Selux instructions and operated within the Ambient Temperature. For additional details and exclusions, see "Selux Terms and Condition of Sale."

**Certifications and Compliance:**

NRTL - For Dry and Damp location  
(I.E. cULus; cCSAus)  
ARRA Compliant

Purelight LED - Round My White



Cable Mounting (C) - 6', 8' and Runs

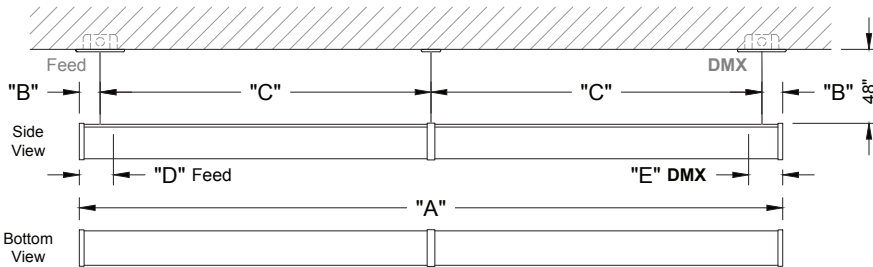

Cable Mounting (C)

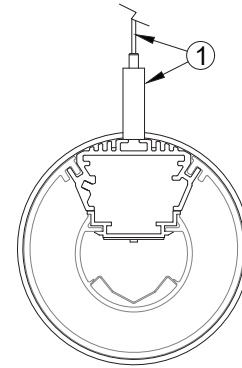

1.  $\varnothing$  1/8" Aircraft Cable with chrome gripper for easy adjustment. (48" max. from ceiling to luminaire)

Cable Mounting (C) - 2', 3' and 4'

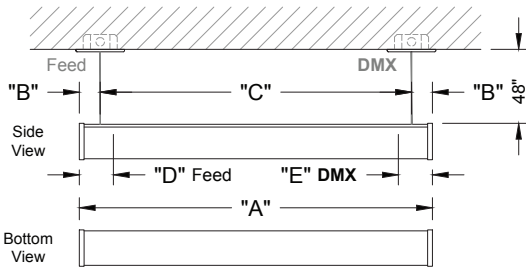

Cable (C) Mounting - Dimensions

Nominal Length	"A" Housing Length		* "B" (Ref.) End Suspensions		"C" Mid. Suspension		"D" Feed Location		"E" DMX In/Out	
	Feet/Inch	MM	Feet/Inch	MM	Feet/Inch	MM	Feet/Inch	MM	Feet/Inch	MM
02 (2 ft.)	2' - 5/16"	618	0'-1 5/16"	34	1'-10"	550	0'-2 1/2"	64	0'-2 1/2"	64
03 (3 ft.)	3' - 5/16"	922	0'-2 1/8"	54	2'-8 1/16"	814	0'-3 5/16"	84	0'-3 5/16"	84
04 (4 ft.)	4' - 5/16"	1227	0'-2 1/8"	54	3'-8 1/16"	1119	0'-3 5/16"	84	0'-3 5/16"	84
06 (6 ft.)	6' - 5/16"	1837	0'-2 1/8"	54	2'-10"	864	0'-3 5/16"	84	0'-3 5/16"	84
08 (8 ft.)	8' - 5/16"	2446	0'-2 1/8"	54	3'-10"	1169	0'-3 5/16"	84	0'-3 5/16"	84

\*Dimension(s) rounded to the nearest 1/16" with a  $\pm$  1/16" (1mm) tolerance.

PL9LR Cable (C) Suspension Detail (Feed location(s) only)

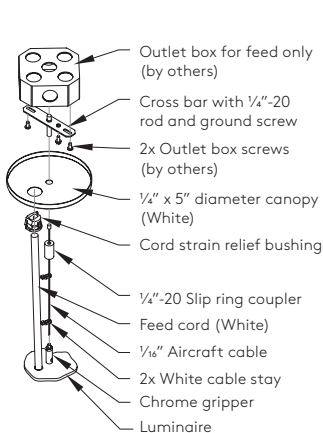

PL9LR Cable (C) Suspension Detail (DMX Feed location(s) only)

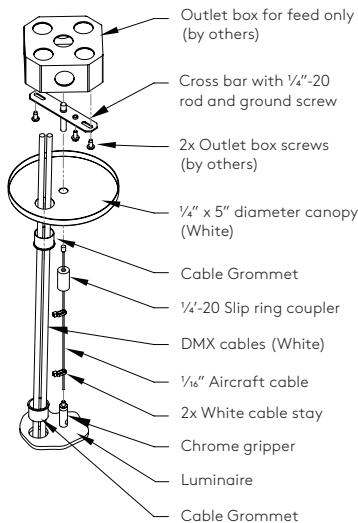

PL9LR Cable (C) Suspension Detail (Non-Feed location(s) only)

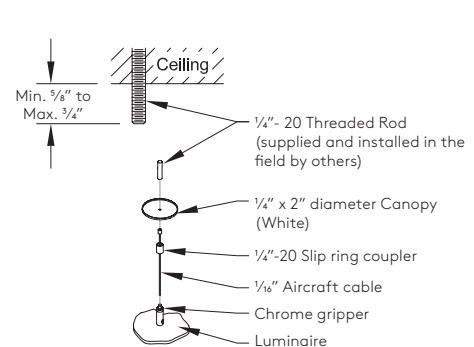

Purelight LED - Round My White



Surface (F) Mounting (Wall/Ceiling) - 6', 8' and Runs

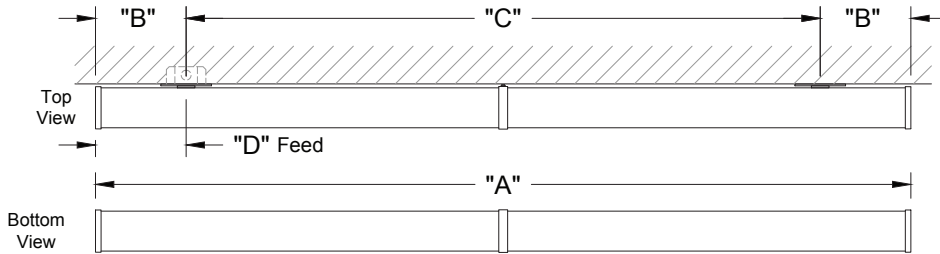

Surface (F) Mounting (Wall/Ceiling) - 2', 3' and 4'

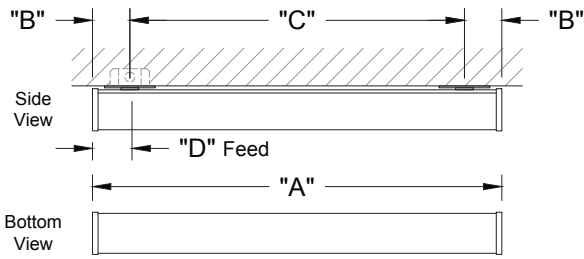

Surface/Wall (F) Mount - Dimensions										
Nominal Length	"A" Housing Length		* "B" (Ref.) End Suspensions		"C" Mid. Suspension		"D" Feed Location		"E" DMX In/Out	
	Feet/Inch	MM	Feet/Inch	MM	Feet/Inch	MM	Feet/Inch	MM	Feet/Inch	MM
02 (2 ft.)	2' - 5/16"	618	0'-2 1/8"	54	1'-8 1/16"	510	0'-2 1/8"	54	0'-2 1/8"	54
03 (3 ft.)	3' - 5/16"	922	0'-3 3/16"	84	2'-5 11/16"	754	0'-3 3/16"	84	0'-3 3/16"	84
04 (4 ft.)	4' - 5/16"	1227	0'-3 3/16"	84	3'-5 11/16"	1059	0'-3 3/16"	84	0'-3 3/16"	84
06 (6 ft.)	6' - 5/16"	1837	0'-8 1/16"	204	4'-8 1/4"	1429	0'-8 1/16"	204	0'-8 1/16"	204
08 (8 ft.)	8' - 5/16"	2446	0'-8 1/16"	204	6'-8 1/4"	2038	0'-8 1/16"	204	0'-8 1/16"	204

\*Dimension(s) rounded to the nearest 1/16" with a ± 1/16" (1mm) tolerance.

Surface Mount (Wall/Ceiling)  
(cover a 2x4 J-box only)

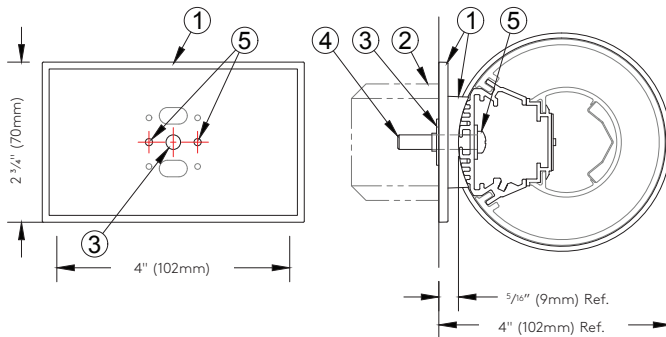

1. Aluminum wall bracket (by Selux).
2. 2"x4" J-box at feed location (supplied and installed by others).
3. 1/4"-20 Threaded Cross Bar (by Selux).
4. 1/2"-20 Phillips screw wall mount (by Selux).
5. M5 x 12 Screw and lock washer (by Selux).

For full details refer to the installation instructions.

	Project 21-12877-4 Date 6/24/2021 Tunable White   Color Tuning	Catalog Number PL9LR 1A32 TW SD C 08 WH 120 DMX SS	Type
	Submitted By 16500, INC	Notes	

Purelight LED - Round My White



**eldoLED Dimming Driver:**

**eldoLED DALI dimming (DMW)**

Luminaires supplied with DUALdrive DALI dimming driver for linear dimming curve. Minimum dimming level preset at factory to 1%. For "dim to dark" (down to 0.1%), please consult factory.

**eldoLED DALI LightShape dimming (DLL)**

Luminaires supplied with DUALdrive DALI dimming driver for eldo LightShape tunable white technology. Tunable white allows dim to dark with the addition of adjustable color temperature to reduce nature's auras.

**eldo DMX dimming (DMX)**

Luminaires supplied with POWERdrive DMX dimming driver for linear dimming curve. Minimum dimming level preset at factory to 1%. For "dim to dark" (down to 0.1%), please consult factory. Selux recommends a maximum of 31 drivers in a DMX universe. DMX fixtures can be grouped together (remove the termination resistor at the end of the fixture and connect the DMX cable from the next fixture).

\*By default, all drivers on a job will be set to the same address. For additional addressing options, please consult factory.

**eldoLED 0-10V LightShape dimming (DTW)**

Luminaires supplied with SOLOdrive 0-10V, single channel dim to dark dimming driver with LightShape Dim to Warm technology. Dim to Warm warms color temperature as the luminaire dims.

\*For control recommendations for eldoLED drivers, please contact eldoLED.

Driver Quantity						
	2 ft.	3 ft.	4 ft.	6 ft.	8 ft.	RUN
<b>DLL/DTW/DMW/DMX drivers</b>	1	1	2	2	2	Approximately 1 driver per 4 ft.

\*For inrush and control current, please refer to the driver manufacturers' spec sheets.

**Wiring Diagrams**

DALI Linear (DMW) / DALI Log (DLL) / 0-10V Lin (DTW)

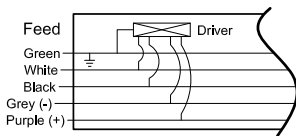

Dimming - DMX eldoLED POWERdrive (DMX) (Individual fixtures)

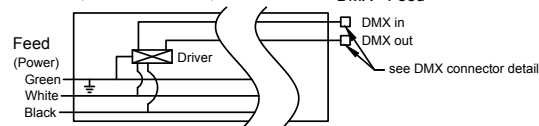

Dimming - DMX eldoLED POWERdrive (DMX) (Runs)

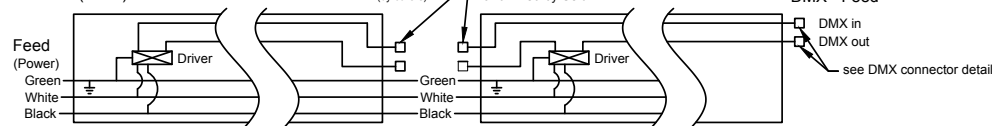

DMW DLL DTW	Green = Ground White = Neutral Black = Hot Grey = (-) Dall Purple = (+) Dall
DMX	DMX = supplied with a DMX in and DMX out control cables. DMX out control cable is supplied with a removable end of run termination resistor.  *When the DMX system is being commissioned the installer to remove the resistors as needed to group fixtures.

**DMX connector detail**

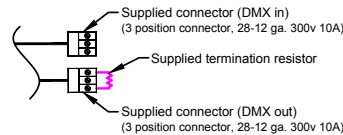

Purelight LED - Round My White



**Wiring Diagrams**  
DMX dimming (DMX)

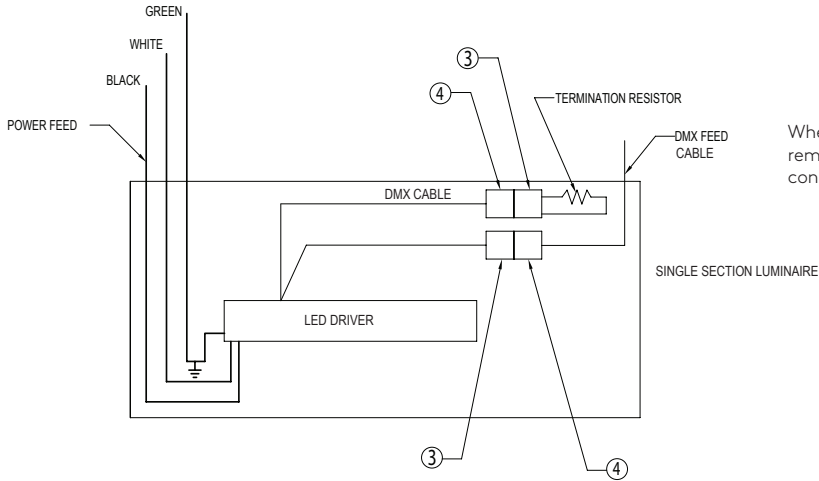

When Daisy Chaining fixtures, remove termination resistor and connect DMX out cable.

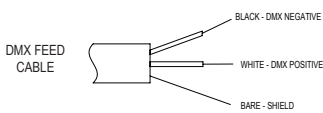
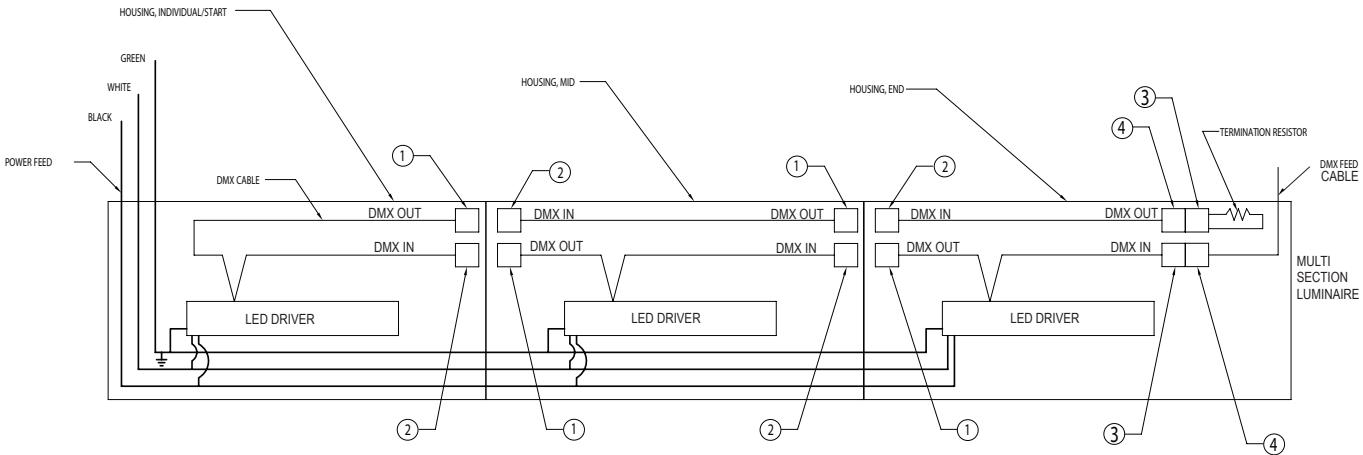

DO NOT GROUND SHIELD IN LUMINAIRE. ONLY CONNECT SHIELD AT CONTROLLER.

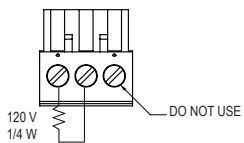

3 POSITION FEMALE CONNECTOR WITH TERMINATION CONNECTOR.

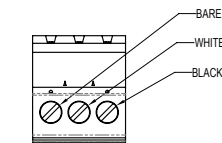

3 POSITION MALE CONNECTOR

④

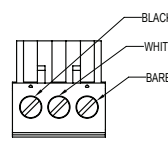

3 POSITION FEMALE CONNECTOR

③

CONNECTORS USED FOR CONTROLLER CONNECTION AND TERMINATION RESISTOR CONNECTION.

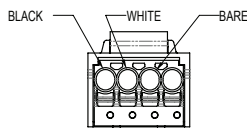

4 POSITION MALE CONNECTOR

①

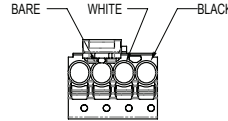

4 POSITION FEMALE CONNECTOR

②

CONNECTORS USED BETWEEN LUMINAIRE SECTIONS.

DMX SIGNAL CONNECTORS

Purelight LED - Round My White



**Fuse (FS)** - Fusing, luminaires supplied with a in-line fuse located on the hot wire for each feed. (supplied with an 8A slow burn fuse).

**Damp Location (DL)** - Luminaires are suitable for use in damp location(s). Examples of such locations include protected areas under canopies, marquees, roofed porches, and similar locations where the fixture(s) are protected from direct contact with rain, snow, or excessive moisture (such as ocean spray). Interior locations include areas subject to moderate degrees of moisture, such as basements and certain barns and cold storage buildings. All solder points on LED boards are conformal coated. The phosphor layer of the LEDs is free of coating to avoid hazing.

**Separate Switching (SS)** - Luminaires available with separately switched 3' or 4' (nominal) sections starting at 6' and up. Luminaire is intended to be wired to the same panel/breaker (not intended for Emergency use).

\* All separately switched (non-EM) circuits within an individual luminaire, linear run, or configuration must be connected to the same branch circuit on-site.

\* To specify this option, the number of separately switched sections and locations of these sections must be provided at time of order.

\* If the project requires different separate switching than outlined above please consult the factory.

**Emergency Circuit (EC)** - Luminaires with EC option compliant to UL 924 listed emergency luminaire. EC luminaires are intended to be wired to separate panels/breakers for emergency use.

- For 2' to 4' nominal luminaires, the entire fixture is wired for operation on emergency circuit.

- For 6' and up nominal luminaires, the first 3' or 4' nominal length is wired for operation by a separate EM circuit by default to meet the required "Life Safety Code" (NFPA 101).

\*If a different configuration is needed please consult the factory.

Purelight LED - Round My White



Photometry

SD Optics / 47W LED / 4000K CCT

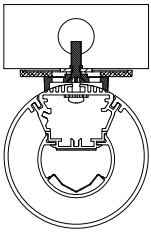

Catalog #: PL9LR-1A45-40-SD-X-04-XX-UNV-DIM  
Report #: 11511554.01  
Delivered Lumens: 3975  
Input Watts: 47W  
Efficacy: 84  
Power Factor: 1.0  
Total Harmonic Distortion:  
CCT: 4000K  
CRI:  
Max Candela: 720 @ 2.5° from Vertical  
Spacing Criterion (0-180): 1.22  
Spacing Criterion (90-270): 1.46  
Spacing Criterion (Diagonal): 1.48

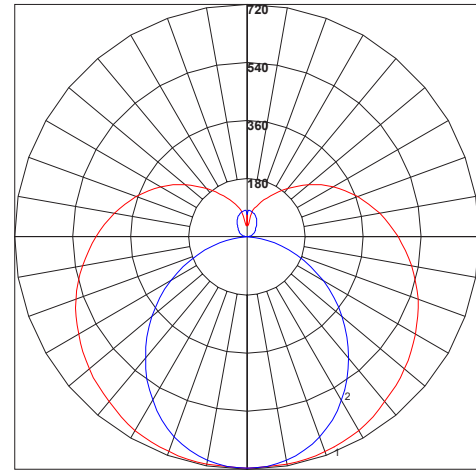

Maximum Candela = 720.246 Located At Horizontal Angle = 22.5, Vertical Angle = 2.5  
# 1 - Vertical Plane Through Horizontal Angles (90 - 270)  
# 2 - Vertical Plane Through Horizontal Angles (0 - 180)

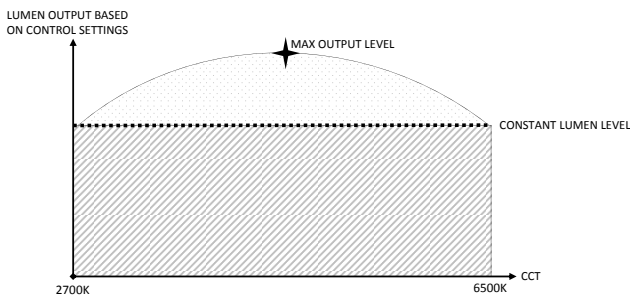

- RECOMMENDED AREA OF OPERATION (CONSTANT LUMEN LEVEL [CLL] SETTINGS)
- ADDITIONAL LUMEN ADJUSTABILITY USING MAX OUTPUT CURVE

This photometry can be used for all CCTs when utilizing the constant lumen level (CLL) curve for My White. For other outputs, please consult the factory.

**My White and the Circadian Rhythm** – Humans have an internal clock that affects everything from sleep patterns to productivity to health. This clock is called the circadian rhythm. As humans evolved in the days before electric lighting, they had natural exposure to various levels (both color temperature and intensity) from the sun. By adjusting electric lighting to mimic the natural hue and intensity of the sun, it can help restore the body to a natural state. Various studies have shown that this can help with alertness, behavioral issues, and productivity. The Selux proprietary My White technology allows you to adjust both the amount and color of your light, creating a comfortable environment for offices, educational facilities, hospitality, or any other installation where varying light could benefit the occupants. Set up the My White luminaires to a whole building solution, and you could create an automatic adjustment to the light to mimic daylight.