

	Project 21-12877-3 Date 6/25/2021 RGB/W   Saturated Color	Catalog Number SUN3 HS-COM	Type
	Submitted By 16500, INC	Notes	

## SUN3C RGB LED DOWNLIGHT COMPONENTS -INDOOR/OUTDOOR

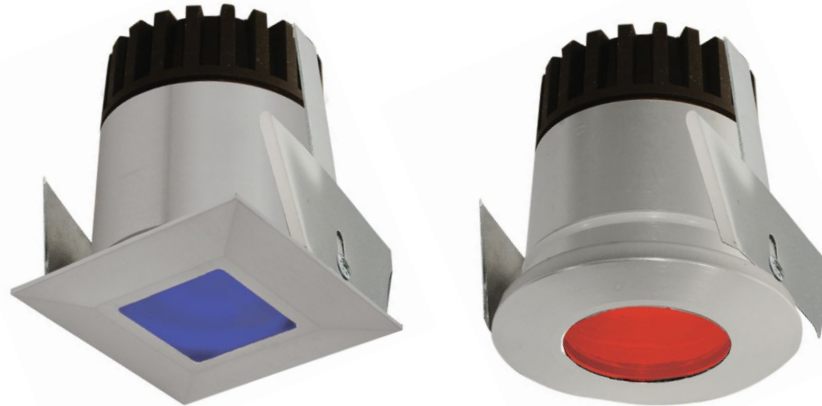
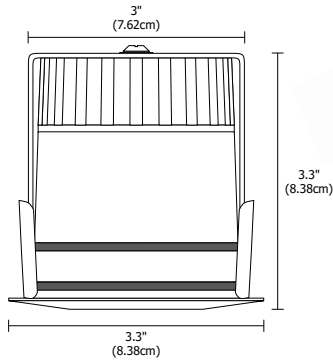

### Description:

The 3 inch round or square recessed SUN3C RGB LED downlight provides dynamic color effects with red, green, and blue LEDs; it features a 16, 23, 36 or 47 degree precise focus and tempered glass lens with marine-grade aluminum beveled edge trim. It is perfect for installation on ceilings with a low clearance (3.2 inch depth). Sun3C RGB is rated for outdoor, ocean front, wet location, shower or indoor applications. New construction IC-Rated housing (SUN3-HS-COM) and Remote Power Supply (PSB-700MA-100W-RGBW) are required and sold separately Fixture includes 5 year warranty.

### Finish:

Satin Aluminum

### Lamp Specification:

Red, Green, and Blue LEDs (Includes Amber LED)

### Remote Power Supply: (Sold Separately)

PSB-700MA-100W-RGBW Constant Current 700MA, 120VAC, 100W, RGBW Power Supply in Box. PSB-700MA-100W-RGBW powers a maximum of 8 fixtures.

### Weight:

1.8 lb (.82 kg)

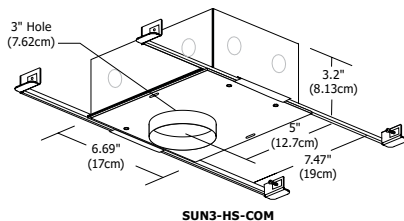
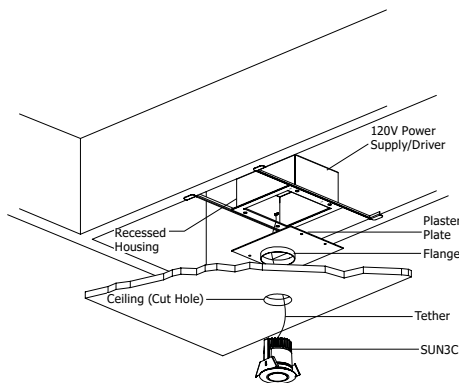

Product	Type
<b>SUN3</b>	<b>HS-COM</b>
SUN3 Sun3	HS-COM Housing

Product	Length in Feet	Description	Color Temperature	Finish
<b>SUN3C</b>	<b>HDL1</b>	<b>RD</b>	<b>RGB</b>	<b>SA</b>
SUN3C Sun3 Ceiling	HDL1 16 Degree Lens HDL2 23 Degree Lens HDL3 36 Degree Lens HDL4 47 Degree Lens	RD Round SQ Square	RGB Red, Green, Blue	SA Satin Aluminum



**OPTICAL ACCESSORIES FOR SUN3 RGB**

**ACCESSORIES**

REV.02.27.17



**Sun3 Louver Lens Holder**

Louver Lens Holders secure onto front of the lamp holding up two lenses or combination of a hexcell louver and lens. Required for securing louvers, lenses and filters in the Sun3.

ACCESSORY	TYPE
<b>SUN3</b>	<b>LLH</b>
LLH	Louver Lens Holder



Hexcell Louver



Micro Louver

**Hexcell and Micro Louver**

The Hexcell Louver eliminates glare from the light beam. The Micro Louver used in step lighting requires both the louver lens holder #SUN3-LLH and the 20 degree filter #LF2-20D.

ACCESSORY	TYPE
<b>LO16</b>	<b>H</b>
LO16 MR16	H Hexcell M Micro Louver

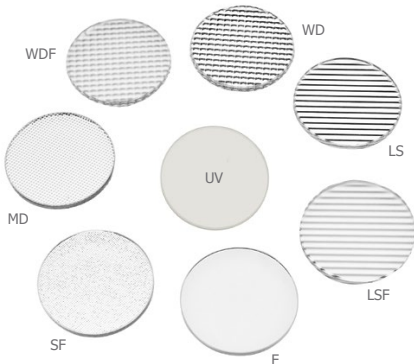

**Optical Lens**

The soft focus lens reduces lamp glare, spread lenses elongate and diffuser lenses diffuse the light beam. UV filter lens allows quality light to pass through while blocking the ultra violet radiation. Louver lens holder #SUN3-LLH not required.

ACCESSORY LENS	OPTICAL TYPE
<b>L16</b>	<b>F</b>
L16 MR16	F Frost SF Soft Focus MD Medium Diffuser WD Wide Diffuser WDF Wide Diffuser Frost LS Linear Spread LSF Linear Spread Frost UV UV Glass

## PSB-700MA-100W-RGBW DRIVER FOR CONSTANT CURRENT RGB LEDS

REV.02.27.17

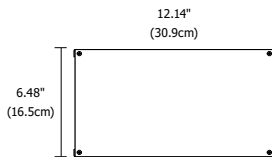

Top View

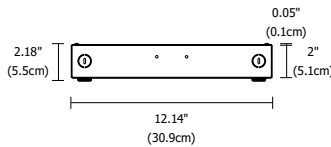

Side View

### Description:

Easy to configure direct current controlled driver/controller for low power, LED lighting applications. Can be integrated in a network or used as a standalone device. Control lighting with an external DMX Controller. Controller allows a show sequence for use in standalone mode.

DMX, DALI and 0-10V dimming and color control. 3-button user interface with LCD display. The easy to navigate menu allows you to set parameters such as the number of channels, DMX or DALI settings for network mode and show, color, dim values for stand alone operation. Lock the driver's configuration and perform a test run of the connected LED groups. Power Supply features short circuit and overload protection.

### Applications:

Indoor

### Power Input:

120-277VAC 50/60Hz

### Power Output:

100W Maximum  
60V Max, 57 typical  
Current range configurable from 200mA to 1,050mA  
(700mA max with Sun3 RGB)

### Output Signal:

USITT DMX512A, RDM

### Dimming:

Logarithm(LOG), Linear(LIN), or Square(SQU)

### Resolution:

8 or 16 bit dimming. 3 or 4 DMX channels used for 8 bit mode

### Dimensions:

12.14" x 6.48" x 2.18"

### Compatible Controllers:

Touch Screen Controller with Power Supply (CTP),  
Color Dial Controller with Power Supply (CDP)

Product	Current	Wattage	Mode
<b>PSB</b>	<b>700MA</b>	<b>100W</b>	<b>RGBW</b>
<small>PSB Power Supply with Enclosure Box</small>	<small>700MA 700 mA</small>	<small>100W 100 Watt</small>	<small>RGBW Red, Green, Blue White (Amber)</small>