

## SS6 RGB WHITE SOFT STRIP 6.3W 24VDC HIGH OUTPUT, COMMERCIAL GRADE RGB+W

REV.02.28.17

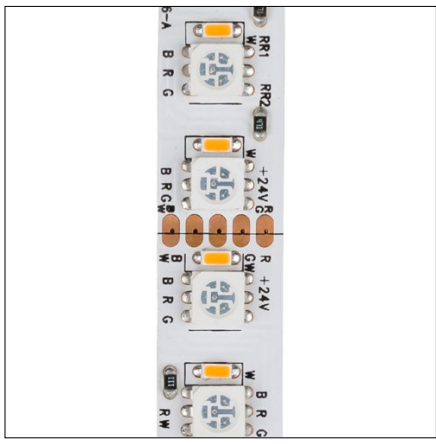

### Description:

Soft Strip (SS6) RGB+W provides dynamic color effects with red, green blue and white (2000K, commercial grade 84+CRI) LEDs. The flexible strip is sold in 1 ft increments up to 16 ft with cutting increments every 3 inches. At 6.3 watts per foot, this system can be controlled using a compatible 24 volt DC power supply with an integrated RGB DMX driver. Self-adhering SS6 mounts to most smooth finished surfaces with industrial strength 3M tape (provided on back of strip); some unfinished surfaces may require screw-in mounting clips (sold separately). Designed for indoor, open-air environments only, SS6 includes a flexible aluminum heat sink to extend LED life. SS6 also includes 1 foot lead wires. Fixtures include a 5 year warranty.

### Applications:

Indoor Only - Under/above cabinet, cove lighting or accent toe kicks, behind sheer curtains, step, entertainment, display, night clubs, molding accent, media room

### Lamp:

LED	Power per Ft (Watts)	Maximum Length	Total Lumens per Watt	Total Lumens per Foot	Lamp Life (Hours)	Dimming
Red, Green, Blue and White 2000K, 84+CRI	6.3	16 ft before refeeding	60	378	50,000	DMX
White Only 2000K 84+CRI	3	16 ft before refeeding	78	234	50,000	DMX

Maximum Length Before Refeeding: 16 Feet

LENGTH IN FEET	TOTAL WATTAGE
1	6
2	12
3	18
4	24
5	30
6	36
7	42
8	48
9	54
10	60
11	66
12	72
13	78
14	84
15	90
16	96

### Controller:

- CTP Touch Screen Controller with Power Supply
- CDP Color Dial Controller with Power Supply
- CDMX1-RGBW DMX 1 Zone RGBW Touch Controller

### 24VDC Power Supply with DMX Driver (Sold Separately):

- PSB-100W-24VDC-RGB 100W output, 120-277V Input
- PSB-200W-24VDC-RGB 100W output, 120-277V Input
- PSB-400W-24VDC-RGB 100W output, 120-277V Input
- PSB-2X100W-24VDC-RGB 2x100W output, 120-277V Input
- PSB-3X100W-24VDC-RGB 3x100W output, 120-277V Input
- PSB-4X100W-24VDC-RGB 4x100W output, 120-277V Input

### Mounting Straps & Clips: (see page 5)

#### SS-SU

Use U-Strap every 6 to 12 inches for extra support (30 per package).

#### SS-ST

Use Tie Strap every 6 to 12 inches for extra support (30 per package).

#### SS-MCL

Screw In Mounting Clip mounts beneath strip, snapping the Strip into place for additional support (10 per package).

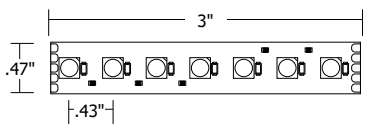

System Voltage Length in Feet Color Temperature

**SS6** - **24V** - **16** - **RGB+W**

SS6 Soft Strip 6.3W per Ft    24V 24 Volt    Sold in 1 ft increments up to 16 ft (Example 16=16')    RGB+W Red, Green, Blue and White (2000K)



**SS6 RGB WHITE SOFT STRIP** 6.3W 24VDC HIGH OUTPUT, COMMERCIAL GRADE RGB+W

REV.02.28.17

**Application:** DMX Control options SS6 RGB+W Soft Strip 6.3W-24V

**Power Supply with DMX Driver:** **PSB-100W-24VDC-RGB** 100 Watt, 120 Volt Input, 24VDC Output

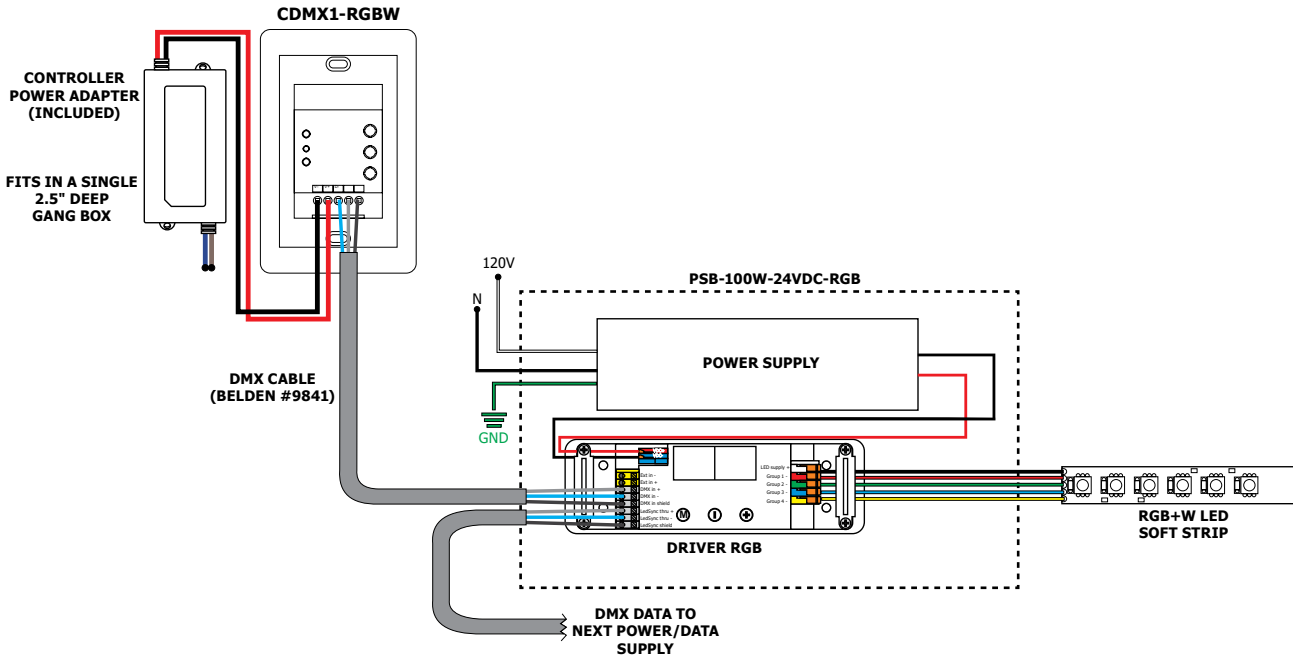

STRIP **DOES NOT** BEND 90°

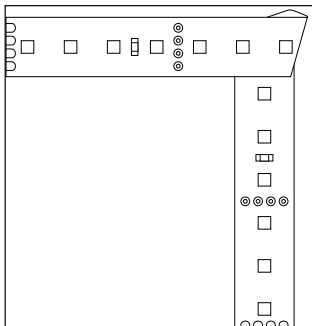

## MOUNTING STRAPS

REV.02.28.17

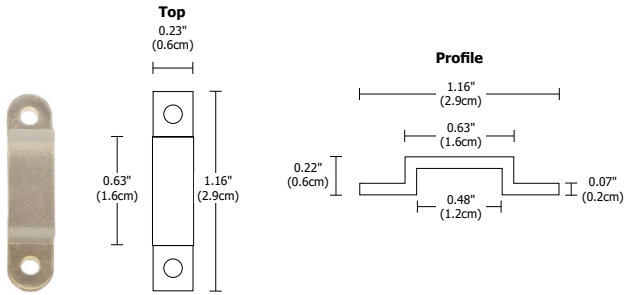

### Soft Strip U Strap

Use U-Strap every 6 to 12 inches for extra support (30 per package).

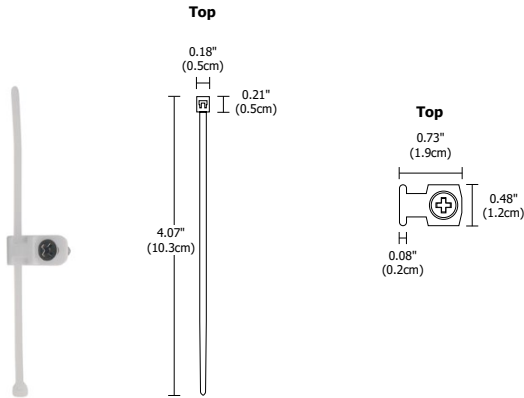
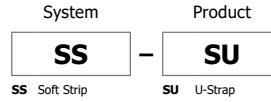

### Soft Strip Tie Strap

Use Tie Strap every 6 to 12 inches for extra support (30 per package).

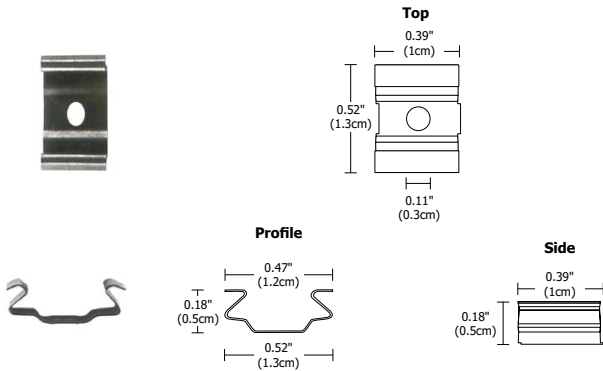
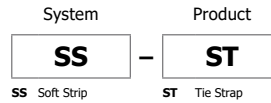

### Soft Strip Mounting Clip

Screw In Mounting Clip mounts beneath strip, snapping the Strip into place for additional support (10 per package).

