

COGNITO² THEATRICAL LIGHTING CONTROL CONSOLE



Models shown: 1. PWCOG DT 1024

WARRANTY

3-year limited warranty. Complete warranty terms located at: <https://www.acuitybrands.com/support/warranty>

NOTE

Actual performance may differ as a result of end-user environment and application. Specifications subject to change without notice.

OVERVIEW

The Cognito²™ solves the complex task of programming shows that include incandescent dimmers, moving lights, and color-changing LED fixtures.

Cognito² features a streamlined, natural language interface to guide you through selecting lights from a vast fixture library, adjusting their attributes, and recording reference libraries, memories and cues.

Once programmed, the show is played back manually or by using show control, time code, or scripting inputs.

Easy to use by novices but powerful enough to create complex looks and shows, the Cognito² is ideal for school theatres, cafeteriums, places of worship, or anywhere a powerful but easy-to-use lighting console is needed.

FEATURES

- Up to 2 Universes (1024 channels) of DMX512 output directly from console
- Supports E1.31 sACN, Pathway ssACN, Pathport Protocol, Art-Net and KiNET DMX-over-Ethernet protocols
- Natural language control uses "real world" terms and labels rather than slot numbers and data-level values
- No hard limits on the number of memories, cues, chases or playbacks
- Continually updated fixture library, currently with over 3,600 commonly available, multi-attribute lights
- Two playbacks, each with intensity fader, Go and Pause buttons
- More than 20 simultaneous virtual playlists or chases
- Four push-buttons for selection of Intensity, Color, Position, and Shape attribute families
- Four push-buttons access Release, Help, Edit and Record functions
- HDMI output for optional 1080p external monitor
- One external and three internal timecode clocks and astronomical or time clock event triggers
- Context-sensitive Help Overlays provide assistance without interrupting workflow
- Support for remote VNC
- Web server for alternate method of backup, restore and software upgrade
- Four auxiliary USB ports for optional mouse, keyboard, flash drives or work lights
- Show files compatible with Choreo; file transfer between devices over network
- Free downloadable off-line editor (OLE) for Windows and macOS
- Lua interpreter for advanced scripting and remote triggering
- Operates on Power-over-Ethernet (PoE) or auxiliary 12-24VDC input (included)
- Rack-mount adapter accessory available

ORDERING INFORMATION

PWCOG		EXAMPLE: PWCOG DT 1024	
Series	Form Factor	Model	
PWCOG Pathway Cognito ² Theatrical Console	DT Desktop	S512 ¹	Starter 512 Channels
		512	512 Channels
		1024	1024 Channels

Accessories

PWPWR WW BARL 24W 24VDC	Power Supply, Wallwart, Barrel, 24 Watts, 24 Volts DC (Spare - One Included)
PWACC COGRM	Pathway Accessory, Cognito Rack Mount Kit
PWACC ADDPRO	Pathway Accessory, Upgrade from Starter to Pro
PWACC ADD512	Pathway Accessory, Add 512 Channels

Notes

1. S512 Starter 512 Model has 512 channels but does not include support for higher-end features such as MIDI Show Control/Time Code, Contact Closure Inputs, Time/Astronomical schedule, etc. See below for a feature breakdown on all 3 models.

SPECIFICATIONS

Electrical

Input Ratings PoE Class 3 device
 12-24VDC auxiliary power input
 15W maximum power consumption
 Dry Contact Closure Input

Regulatory Compliance CE

Mechanical

Dimensions 18.3" W x 3.1" H x 11.2" D (465mm W x 79mm H x 285mm D)

Weight 8.0 lbs (3.6 kg)

Environmental

Operating Temperature 14°F to 122°F (-10°C to 50°C)

Relative Humidity 5-95%, non-condensing

Standard Compliance RoHS 2011/65/EU + A1 2015/863

General

Compliance ANSI E1.11 DMX512-A R2013
 ANSI E1.31 sACN - Streaming ACN
 IEEE 802.3af Power-over-Ethernet
 California Title 1.81.26, Security of Connected Devices
 RS-232
 MIDI Show Control (MSC)
 MIDI Time Code (MTC)
 HDMI - HD1080 - 1920x1080 external monitor support

PART NUMBER CROSS-REFERENCE

PREVIOUS	NEW	
Part Number	Catalog Number	Description
0700-7111	PWCOG DT S512	Cognito 2 Theatrical Console, Desktop, Starter 512 Channels
0700-7112	PWCOG DT 512	Cognito 2 Theatrical Console, Desktop, 512 Channels
0700-7113	PWCOG DT 1024	Cognito 2 Theatrical Console, Desktop, 1024 Channels
0700-7814	PWACC ADDPRO	Pathway Accessory, Upgrade from Starter to Pro
0700-7815	PWACC ADD512	Pathway Accessory, Add 512 Channels

WIRING

DMX512 PINOUT	
Purpose	XLR Pin #
Shield / Common	1
Data - (complement)	2
Data + (true)	3
Not Used	4
Not Used	5
Not Used - Do Not Connect	N/A
Not Used - Do Not Connect	N/A

MODEL FEATURE COMPARISON

Model	Starter 512	512	1024
Feature			
DMX Output Addresses	512	512	1024
Pathport Protocol	Yes	Yes	Yes
E1.31 sACN	Yes	Yes	Yes
Pathway ssACN	Yes	Yes	
Art-Net	Not Enabled	Yes	Yes
KiNET	Not Enabled	Yes	Yes
DMX512 Output Ports	1	2 ¹	2
DMX512 Input Ports	Not Enabled	Yes	Yes
MIDI Show Control/Timecode	Not Enabled	Yes	Yes
RS232 Serial/Telnet Lua Support	Not Enabled	Yes	Yes
Contact Closure	Not Enabled	3	3
Time/Astronomical Schedule	Not Enabled	Yes	Yes
90-240VAC Power Supply	Yes	Yes	Yes
Dust Cover	Yes	Yes	Yes
Rackmount Adapter	Optional Accessory	Optional Accessory	Optional Accessory

Notes

1. Universe 1 is repeated on both Output Ports

CONSOLE CONTROLS AND CONNECTIONS

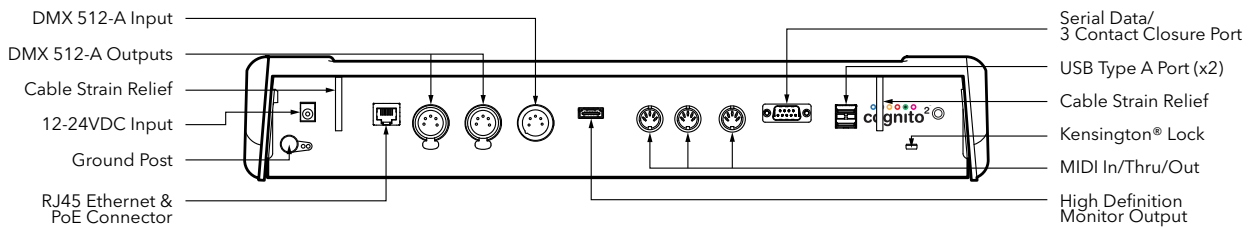
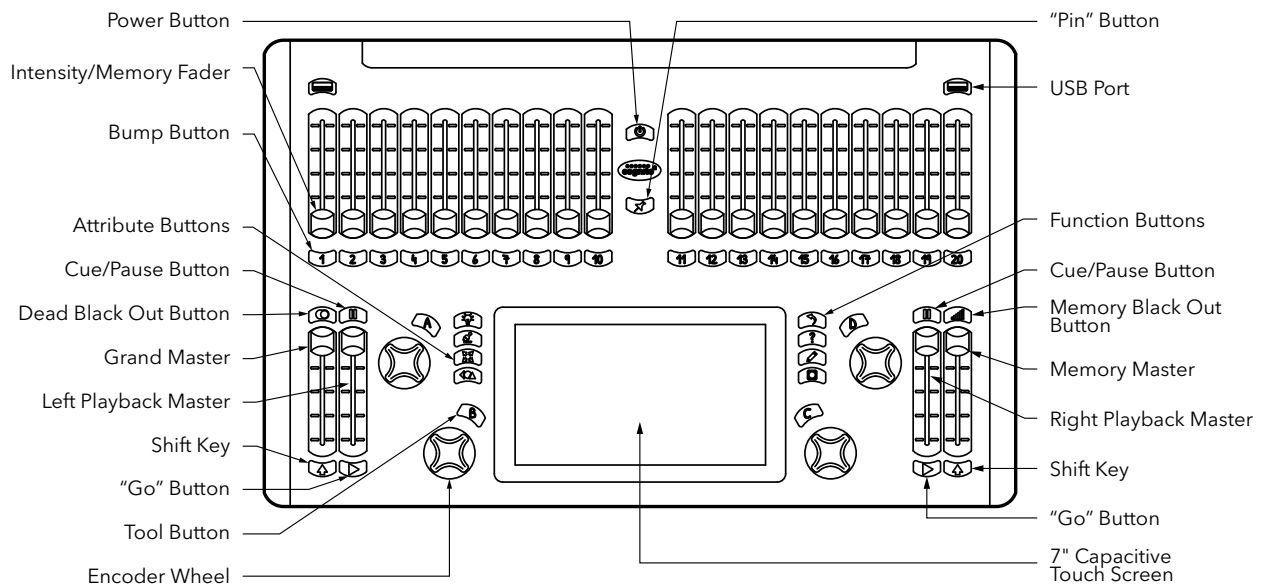

DIMENSIONS

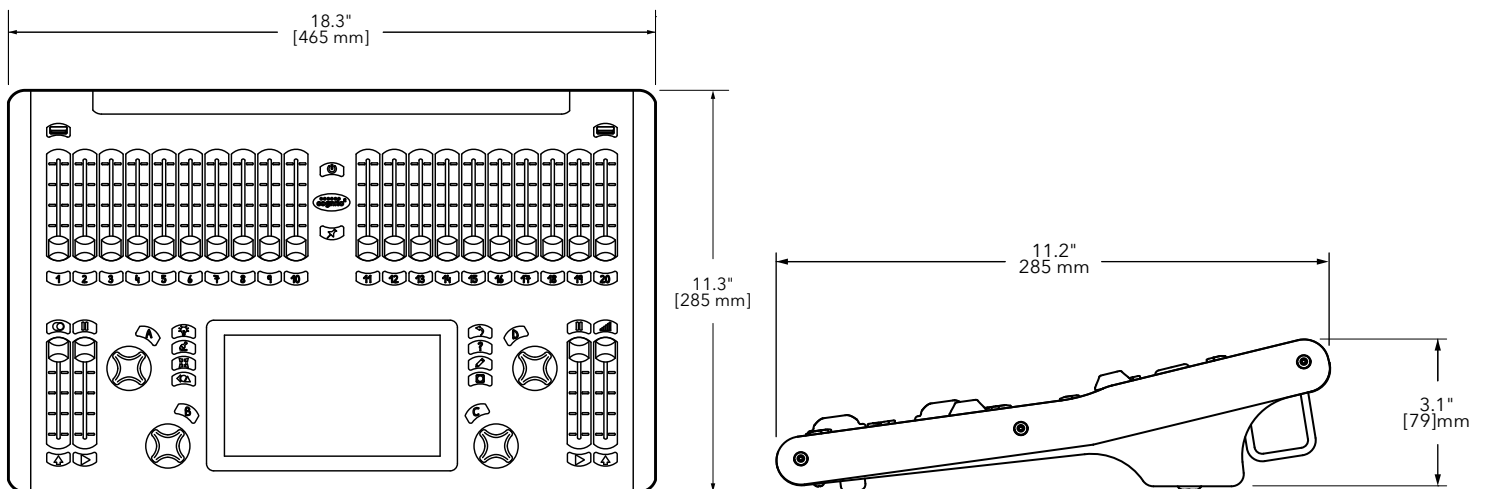

RACK-MOUNT ACCESSORY

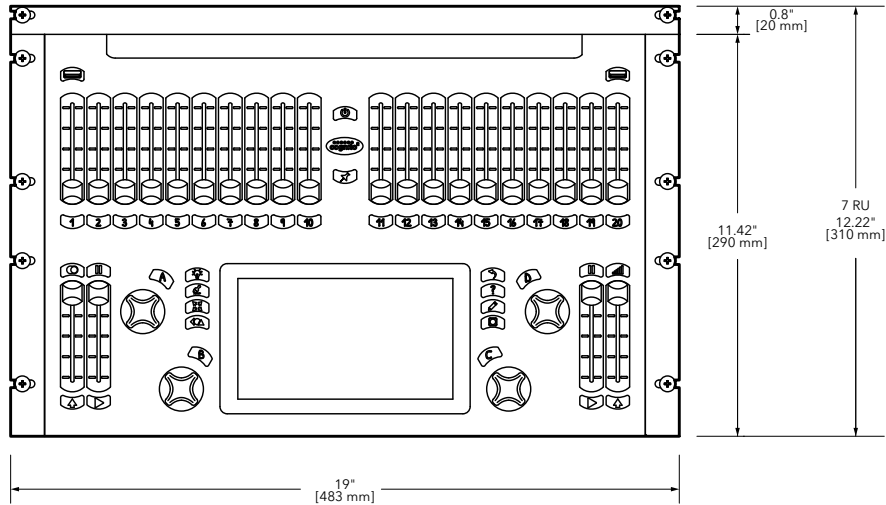

SAMPLE SCREEN SHOTS

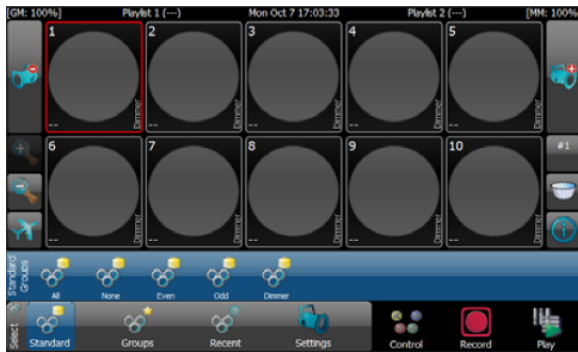

Select



Control

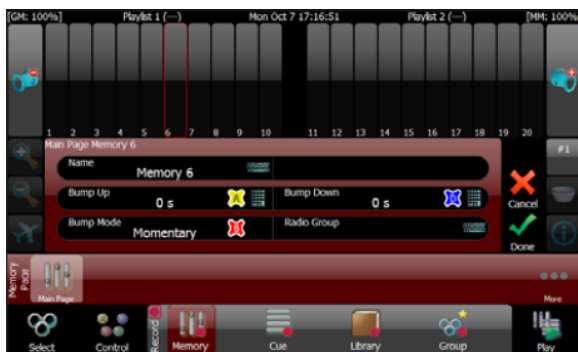

Record

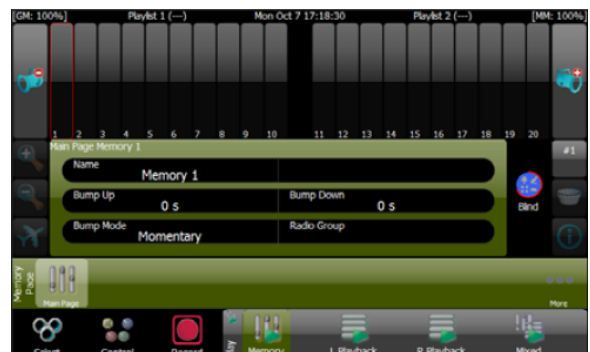

Play

APPLICATION RISER

DMX-over-Ethernet

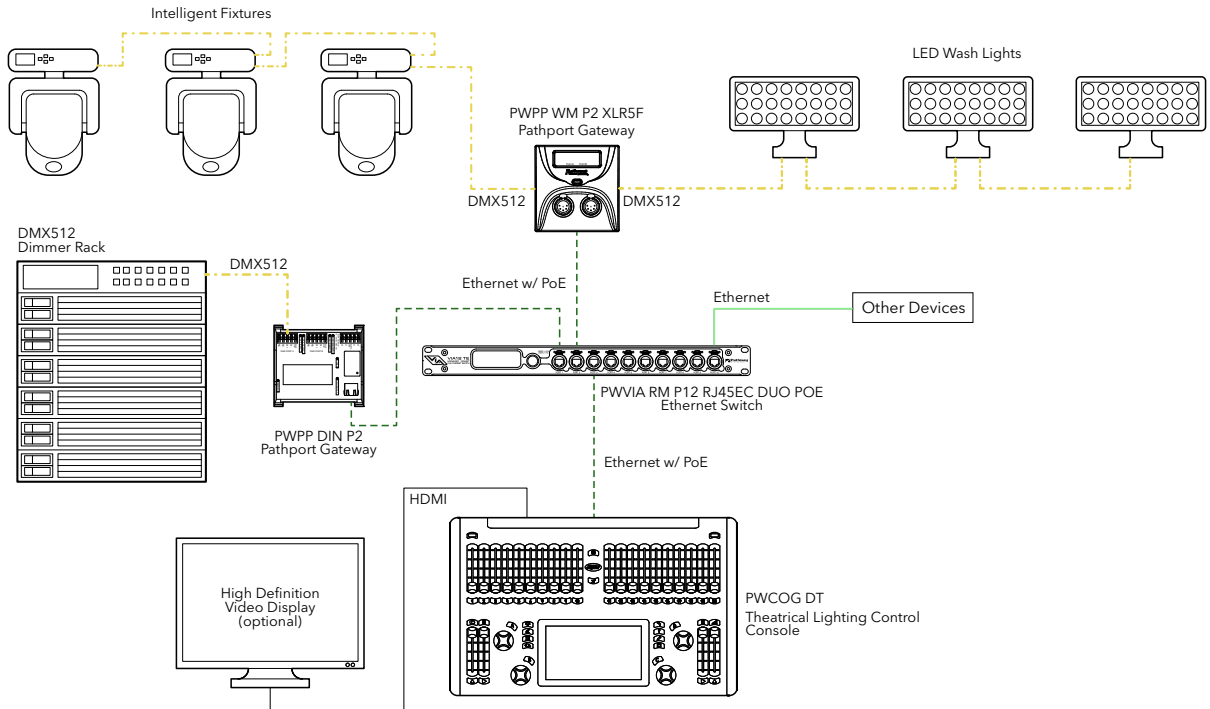

DMX512

