



M100 My White  
LED Direct/Indirect Tunable White



Order Code: L1DI - 1A32 - 1A32 - TW - \_\_\_\_\_ - \_\_\_\_\_ - \_\_\_\_\_ - \_\_\_\_\_ - \_\_\_\_\_ - \_\_\_\_\_ - \_\_\_\_\_ - \_\_\_\_\_

Series	L1DI M100 LED Direct/Indirect						
Direct Light Engine	1A32 <sup>1</sup> 654lm/8.6W per foot						
Indirect Light Engine	1A32 <sup>1</sup> 654lm/8.6W per foot						
CCT	TW Tunable White - 2700K through 6500K 90+ CRI						
Direct Shielding	LW LED Optimized White lens	MI Clear Lens with Microprism	NB LMO Symmetric with Satine Lens	A2 LMO Asymmetric 20° Wall Washer with Satine Lens	A5 LMO Asymmetric 5° Wall Grazer with Satine Lens	BW LMO Batwing with Satine Lens	PX <sup>6</sup> Blank Cover
Indirect Shielding	LW LED Optimized White Lens	MI Clear Lens with Microprism	WB LMO Wide Batwing				
Mounting	C Cable	S Swivel Stem	RS Rigid Stem	W Wall Mount			
Nominal Fixture Length	02 2 ft.	04 4 ft.	06 6 ft.	08 8 ft.	10 10 ft.	12 12 ft.	XX Runs (over 12") are available in 2" nominal increments, round up to the nearest foot and replace the "xx" with the # (i.e. 14=14" nominal)
Finish	WH White	BL Semi-Matte Black	SV Silver	SP Specify Premium Color			<sup>4</sup> Custom colors are available, please consult factory
Voltage	120 120V	277 277V	UNV 120V through 277V 50/60hz capable				
Fixture Options	DL <sup>2</sup> Damp Location Rated	FS <sup>2</sup> In-Line Fuse	SS <sup>2,3</sup> Separate Switching	WC <sup>3</sup> Wall Controller Connections			<sup>2</sup> For DMX, please consult factory. See page 8 for full details and restrictions. <sup>3</sup> See page 8 for details <sup>4</sup> For use with DMX only. See page 2 for details.
Dimming Options	DMW <sup>5</sup> eidoLED 1% DUALdrive DALI (Linear)	DMX <sup>5</sup> eidoLED POWERdrive DMX (Linear)	DLL <sup>5</sup> eidoLED DALI (Logarithmic) Dimming (Linear) CCT balance	DTW <sup>5</sup> eidoLED SOLOdrive 0-10V LightShape (linear)	DMT Lutron T-Series for Quantum Controls only (consult factory)		
Emergency Options	EC <sup>6</sup> Emergency Circuit Wiring						<sup>6</sup> See page 8 for full details and restrictions

M100 My White  
LED Direct/Indirect

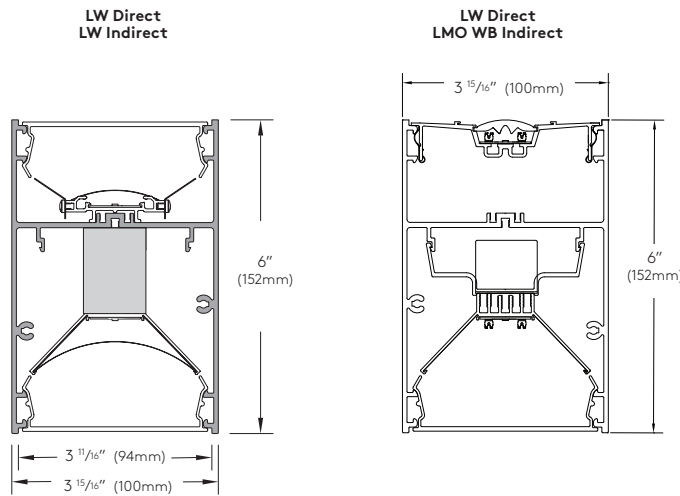

**Construction:**

**Housing** - Continuous, low copper 6063-T6 extruded aluminum profile with aluminum endcaps, available as Individual fixtures (up to 12') or Runs.

**Geartray** - Low copper 6063-T6 extruded aluminum profile.

**Shielding** - Extruded, impact resistant acrylic snap in lens:

- LED Optimized White Lens (LW)
- Clear Lens with Microprism (MI)
- "LMO" Wide Batwing (WB) - Indirect Only
- "LMO" refers to the Selux proprietary LED optical system - Light modulation optics. These lenses (other than WB) are offered in M100 behind a Satine Lens for even illumination and comfortable lit appearance. (Direct only)
- "LMO" Symmetric Lens (NB)
- "LMO" Asymmetric 20° Wall Washer (A2)
- "LMO" Asymmetric 5° Wall Grazer (A5)
- "LMO" Batwing (BW)

**Mounting(s)**- 1/16" Aircraft Cable, Ø5/8" Swivel or Rigid Steel Stem, Wall Bracket, (see pages 3 through 5 for details).

\*\*Cable, Stem and Wall mountings may not be symmetrical for Runs due to the use of modular housing lengths. If symmetrical suspensions are required please consult the factory.

**Standard Luminaire lengths** - All standard luminaires are supplied in nominal lengths to ensure full, even, illumination. Runs are available in approximately 2' increments starting at the nominal 12' fixture length.

\*\*Individual luminaires are not joinable in the field.

**Exact length luminaires** - Individual luminaires and Runs, and configuration are available in exact lengths to meet your project needs. Please consult factory with you requirements.

\*\* Lens luminance may soften at the very ends of the straight sections for exact length luminaires.

**L10 Joiner(s)** - Runs are supplied in multiple housing that are joined together in the field using the supplied L10 Joining System. This allows ease of installation and ensures a uniform appearance (see page 7 for detail).

**Electrical/Performance:**

**Constant Lumen Level (CLL) Curve** - Selux recommends utilizing the Constant Lumen Level (CLL) curve for the My White product. This is achieved using an algorithm programmed into the controls for driving the two channels of the driver simultaneously so that while adjusting the CCT, the lumen output remains the same. For recommended controls for CLL, please consult Selux.

**Max Output** - An alternate way to control the output is by having each channel of the driver controlled individually while changing the CCT. Controlling the channels individually can result in a higher lumen level (see chart on Photometry page 9), though the CCT and output may vary.

**LED Light Engine** - Brand-name mid-power LEDs create a high efficiency LED light engine with a reported luminous flux maintenance at 60,000 hours of 88% based on LM-80 test reports. The rated lumen maintenance life is L70 (10k) > 60,000 hours. Luminous flux values calculated in accordance to TM-21 procedures based on LM-80 compliant reported measurement data. For Title 24 compliant model numbers, please consult factory.

**Photometrics** - Consult website or factory for IES Files. Photometric lumen measurement complies with IES LM-79-08 testing procedures. Due to the LED manufacturer's tolerances, the listed output has a ±5% tolerance.

**CCT** - Tunable CCT from 2700K through 6500K tolerance within a 3-step MacAdam ellipse.

**CRI** - 90+.

**Driver** - High efficiency, constant current, soft start, Electronic Class 2 with a PFC>0.90. For more detailed information on the available drivers please see page 7.

**Wall Controller** - Optional wall controller can be ordered for use with DMX fixtures. See DMX controller spec sheet for more details.

**Thermal Performance:**

**Ambient Operating Temperature** - Luminaires suitable for maximum ambient temperature of 35°C (95°F). Minimum ambient temperature of -20°C (-4°F).

**Luminaire Finish:**

**Powder Coat** - All Selux luminaires are finished in high quality polyester powder coating in our Tiger Drylac certified facility and are tested in accordance with test specifications for coatings from ASTM and PCI.

All products undergo a five stage intensive pretreatment process where product is thoroughly cleaned, phosphated, and sealed. Selux powder coated products provide excellent salt and humidity resistance as well as ultraviolet resistance for color retention.

Standard interior colors are White (WH), Semi-Matte Black (BL) and Silver (SV). Selux premium colors (SP) are available, please specify from your Selux color selection guide.

**Warranty:**

**5 Year Limited LED Luminaire Warranty** - Selux offers a 5 Year Limited Warranty to the original purchaser that the M100 MyWhite LED luminaire shall be free from defects in material and workmanship for up to five (5) years from date of shipment. This limited warranty covers the LED driver and LED light engine when installed according to Selux instructions and operated within the Ambient Temperature. For additional details and exclusions, see "Selux Terms and Condition of Sale."

**Certifications and Compliance:**

- NRTL - For Dry and Damp location (I.E. cULus)
- ARRA Compliant
- RoHS Compliant

M100 My White  
LED Direct/Indirect



Cable Mounting (C)

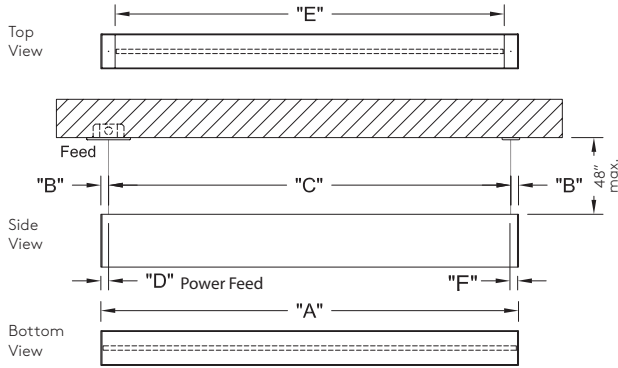

Cable Mounting (C)

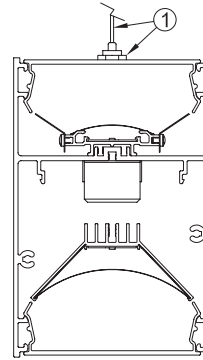

1.  $\varnothing$  1/16" Aircraft Cable with chrome gripper for easy adjustment (48" max. from ceiling to luminaire).

Cable Mounting (C) - Dimensions												
Nominal Length	"A" Housing Length		* "B" (Ref.) End Suspensions		"C" Mid. Suspension		"D" Power Feed Location		"E" Illuminated Length		"F" DMX In/Out	
	Feet/Inch	MM	Feet/Inch	MM	Feet/Inch	MM	Feet/Inch	MM	Feet/Inch	MM	Feet/Inch	MM
02 (2 ft.)	2' - 1/4"	616	0' - 7/8"	22	1' - 10 1/2"	572	0' - 7/8"	22	1' - 9"	534	0' - 7/8"	22
04 (4 ft.)	3' - 11 7/16"	1205	0' - 7/8"	22	3' - 9 11/16"	1161	0' - 7/8"	22	3' - 8 3/16"	1123	0' - 7/8"	22
06 (6 ft.)	5' - 11 7/16"	1815	0' - 7/8"	22	5' - 9 11/16"	1770	0' - 7/8"	22	5' - 8 1/4"	1733	0' - 7/8"	22
08 (8 ft.)	7' - 11 7/16"	2424	0' - 7/8"	22	7' - 9 11/16"	2380	0' - 7/8"	22	7' - 8 3/16"	2342	0' - 7/8"	22
10 (10 ft.)	9' - 11 7/16"	3034	0' - 7/8"	22	9' - 9 11/16"	2990	0' - 7/8"	22	9' - 8 1/4"	2952	0' - 7/8"	22
12 (12 ft.)	11' - 11 7/16"	3643	0' - 7/8"	22	11' - 9 11/16"	3599	0' - 7/8"	22	11' - 8 3/16"	3561	0' - 7/8"	22

\*Dimension(s) rounded to the nearest 1/16" with a  $\pm$  1/16" (1mm) tolerance.

L10 Cable (C) Suspension Detail (DMX Feed location(s) only)

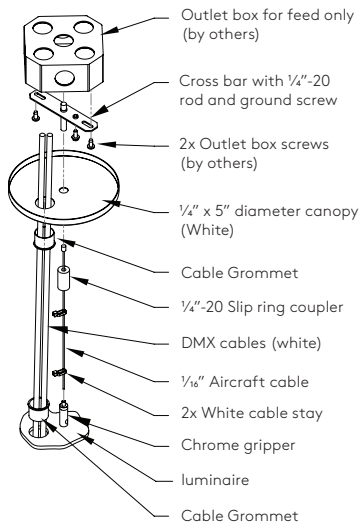

L1DI Cable (C) Suspension Detail (Power Feed location(s) only)

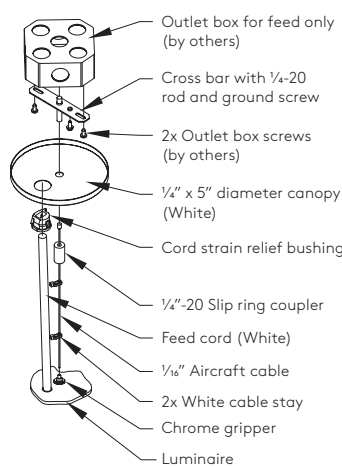

L1DI Cable (C) Suspension Detail (Non-Feed location(s) only)

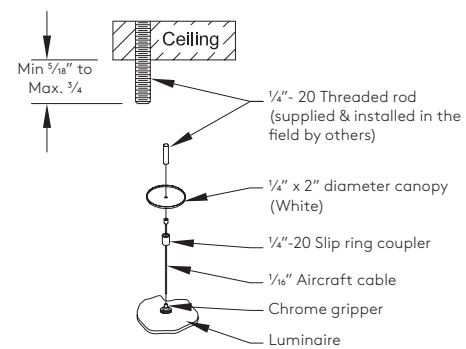

M100 My White  
LED Direct/Indirect



Stem Mounting (S & RS)

Swivel Stem (S) & Rigid Stem (RS) Mounting

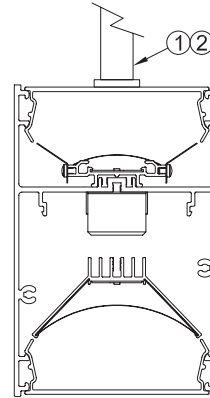
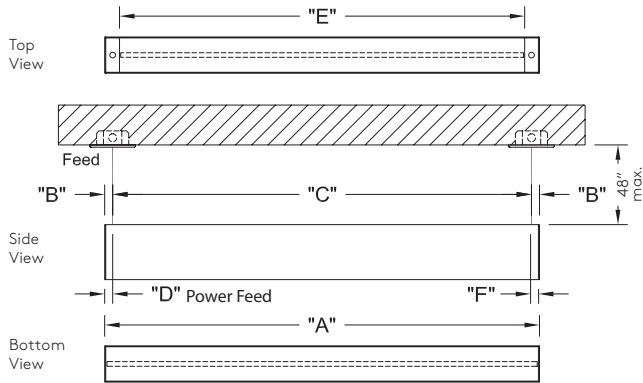

1.  $\varnothing \frac{3}{8}$ " Swivel Stem provides 30° swivel and **can be cut in field** (48" max. from ceiling to luminaire).
2.  $\varnothing \frac{3}{8}$ " Rigid Stem is fixed and is **not able to be cut/adjusted in field** (48" max. from ceiling to luminaire).

Swivel (S) & Rigid Stem (RS) Mountings - Dimensions

Nominal Length	"A" Housing Length		* "B" (Ref.) End Suspensions		"C" Mid. Suspension		"D" Power Feed Location		"E" Illuminated Length		"F" DMX In/Out	
	Feet/Inch	MM	Feet/Inch	MM	Feet/Inch	MM	Feet/Inch	MM	Feet/Inch	MM	Feet/Inch	MM
02 (2 ft.)	2' - 1/4"	616	0' - 7/8"	22	1' - 10 1/2"	572	0' - 7/8"	22	1' - 9"	534	0' - 7/8"	534
04 (4 ft.)	3' - 11 7/16"	1205	0' - 7/8"	22	3' - 9 11/16"	1161	0' - 7/8"	22	3' - 8 3/16"	1123	0' - 7/8"	1123
06 (6 ft.)	5' - 11 7/16"	1815	0' - 7/8"	22	5' - 9 11/16"	1770	0' - 7/8"	22	5' - 8 1/4"	1733	0' - 7/8"	1733
08 (8 ft.)	7' - 11 7/16"	2424	0' - 7/8"	22	7' - 9 11/16"	2380	0' - 7/8"	22	7' - 8 3/16"	2342	0' - 7/8"	2342
10 (10 ft.)	9' - 11 7/16"	3034	0' - 7/8"	22	9' - 9 11/16"	2990	0' - 7/8"	22	9' - 8 1/4"	2952	0' - 7/8"	2952
12 (12 ft.)	11' - 11 7/16"	3643	0' - 7/8"	22	11' - 9 11/16"	3599	0' - 7/8"	22	11' - 8 3/16"	3561	0' - 7/8"	3561

\*Dimension(s) rounded to the nearest 1/16" with a  $\pm \frac{1}{16}$ " (1mm) tolerance.

L1DI Swivel Stem (S) Suspension Detail  
(feed wires through stem supplied by others)

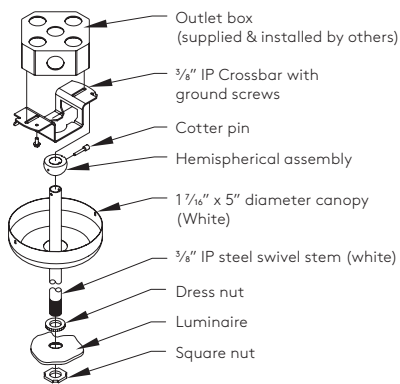

L1DI Rigid Stem (RS) Suspension Detail  
(feed wires through stem supplied by others)

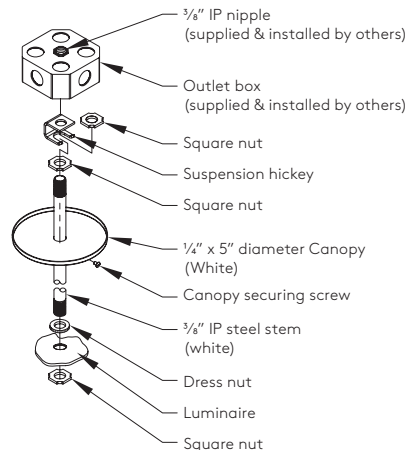

M100 My White  
LED Direct/Indirect

**selux**

**Wall Mounting (W)**

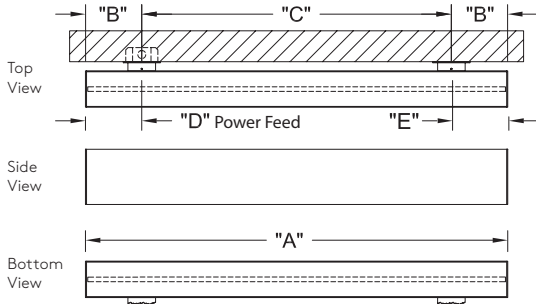

Wall (W) Mount - Dimensions										
Nominal Length	"A" Housing Length		* "B" (Ref.) End Suspensions		"C" Mid. Suspension		"D" Power Feed Location		"E" DMX In/Out	
	Feet/Inch	MM	Feet/Inch	MM	Feet/Inch	MM	Feet/Inch	MM	Feet/Inch	MM
<b>02 (2 ft.)</b>	2' - 1/4"	616	0' - 3 1/8"	79	1' - 6 1/16"	458	0' - 3 1/8"	79	0' - 3 1/8"	79
<b>04 (4 ft.)</b>	3' - 11 7/16"	1205	0' - 6 1/8"	156	2' - 11 3/16"	894	0' - 6 1/8"	156	0' - 6 1/8"	156
<b>06 (6 ft.)</b>	5' - 11 7/16"	1815	0' - 6 1/8"	156	4' - 11 3/16"	1504	0' - 6 1/8"	156	0' - 6 1/8"	156
<b>08 (8 ft.)</b>	7' - 11 7/16"	2424	0' - 6 1/8"	156	6' - 11 3/16"	2113	0' - 6 1/8"	156	0' - 6 1/8"	156
<b>10 (10 ft.)</b>	9' - 11 7/16"	3034	0' - 6 1/8"	156	8' - 11 3/16"	2723	0' - 6 1/8"	156	0' - 6 1/8"	156
<b>12 (12 ft.)</b>	11' - 11 7/16"	3643	0' - 6 1/8"	156	10' - 11 3/16"	3332	0' - 6 1/8"	156	0' - 6 1/8"	156

\*Dimension(s) rounded to the nearest 1/16" with a ± 1/16" (1mm) tolerance.

Wall Mount (W)  
(Covers a 4x4 or 2x4 J-box)

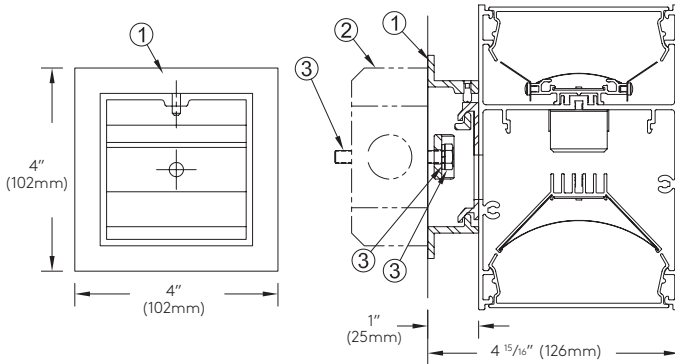

1. Aluminum wall bracket (by Selux).
2. 4"x4" or 2"x4" J-box at feed location (supplied and installed by others).
3. 1/4"-20 Threaded rod, 1/4"-20 lock washer and 1/4"-20 nut required to anchor the wall bracket. Mounting hardware supplied and installed to code by others.

M100 My White  
LED Direct/Indirect



**eldoLED Dimming Driver:**

**eldoLED DALI dimming (DMW)**

Luminaires supplied with DUALdrive DALI dimming driver for linear dimming curve. Minimum dimming level preset at factory to 1%. For "dim to dark" (down to 0.1%), please consult factory.

**eldoLED DALI LightShape dimming (DLL)**

Luminaires supplied with DUALdrive DALI dimming driver for eldo LightShape tunable white technology. Tunable white allows dim to dark with the addition of adjustable color temperature to reduce nature's auras.

**eldo DMX dimming (DMX)**

Luminaires supplied with POWERdrive DMX dimming driver for linear dimming curve. Minimum dimming level preset at factory to 1%. For "dim to dark" (down to 0.1%), please consult factory. Selux recommends a maximum of 31 drivers in a DMX universe. DMX fixtures can be grouped together (remove the termination resistor at the end of the fixture and connect the DMX cable from the next fixture).

\*By default, all drivers on a job will be set to the same address. For additional addressing options, please consult factory.

**eldoLED 0-10V LightShape dimming (DTW)**

Luminaires supplied with SOLOdrive 0-10V, single channel dim to dark dimming driver with LightShape Dim to Warm technology. Dim to Warm warms the color temperature as the luminaire dims.

\*For control recommendations for eldoLED drivers, please contact eldoLED.

Driver Quantity (consult factory for SS option driver quantity)						
	2 ft.	4 ft.	6 ft.	8 ft.	10 ft.	12 ft.
<b>DLL/DTW/DMW/DMX drivers</b>	1	2	3	4	5	6
						<b>RUN</b>
						Approximately 2 drivers per 4 ft.

\*For inrush and control current, please refer to the driver manufacturers' spec sheets.

**Wiring Diagrams**

DALI Linear (DMW) / DALI Log (DLL) / 0-10V Lin (DTW)

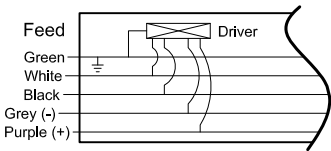

DMW DLL DTW	Green = Ground White = Neutral Black = Hot Grey = (-) Dali Purple = (+) Dali
DMX	DMX = supplied with a DMX in and DMX out control cables. DMX out control cable is supplied with a removable end of run termination resistor.  *When the DMX system is being commissioned the installer to remove the resistors as needed to group fixtures.

Dimming - DMX eldoLED POWERdrive (DMX) (Individual fixtures)

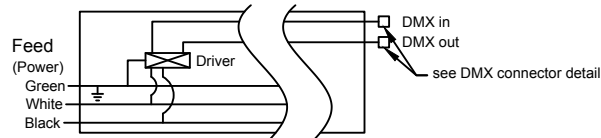

**DMX connector detail**

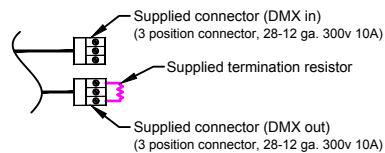

Dimming - DMX eldoLED POWERdrive (DMX) (Runs)

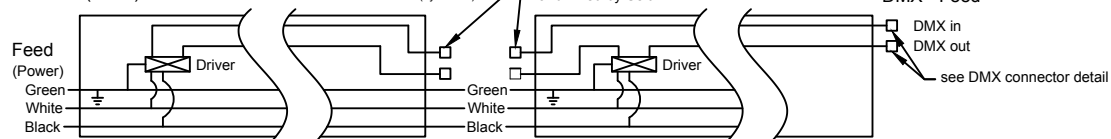

M100 My White  
LED Direct/Indirect



**Wiring Diagrams**  
DMX dimming (DMX)

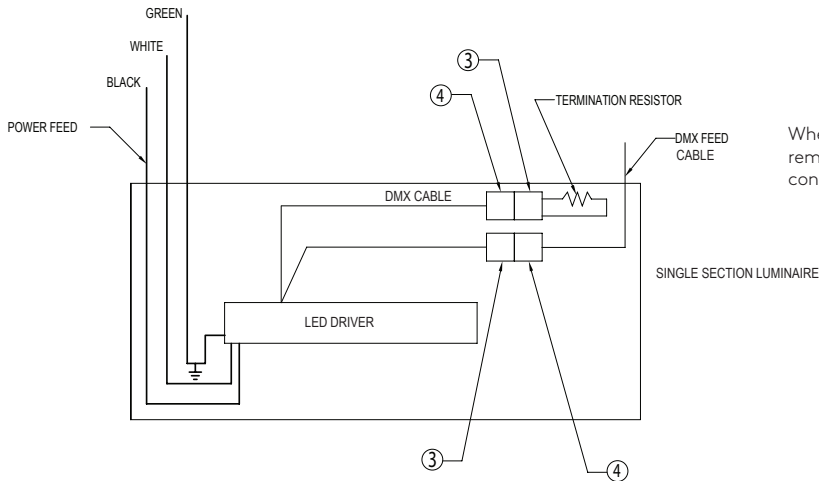

When Daisy Chaining fixtures, remove termination resistor and connect DMX out cable.

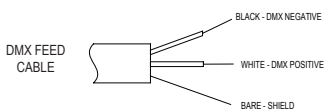
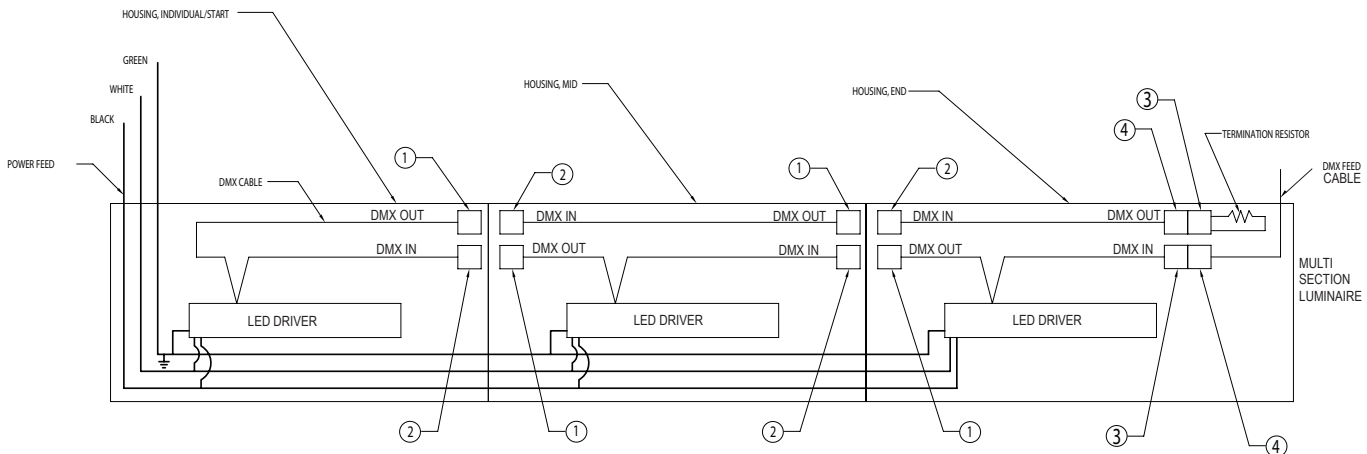

DO NOT GROUND SHIELD IN LUMINAIRE. ONLY CONNECT SHIELD AT CONTROLLER.

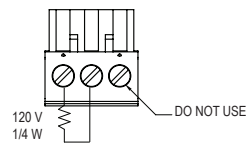

3 POSITION FEMALE CONNECTOR WITH TERMINATION CONNECTOR.

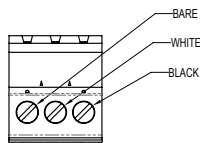

3 POSITION MALE CONNECTOR

④

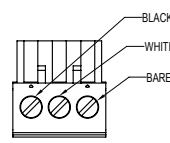

3 POSITION FEMALE CONNECTOR

③

CONNECTORS USED FOR CONTROLLER CONNECTION AND TERMINATION RESISTOR CONNECTION.

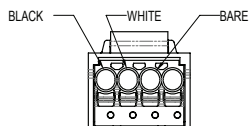

4 POSITION MALE CONNECTOR

①

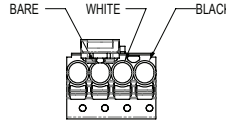

4 POSITION FEMALE CONNECTOR

②

CONNECTORS USED BETWEEN LUMINAIRE SECTIONS.

DMX SIGNAL CONNECTORS

M100 My White  
LED Direct/Indirect

**selux**

**Fuse (FS)** - Fusing, luminaires supplied with a in-line fuse located on the hot wire for each feed (supplied with an 8A slow burn fuse).

**Damp Location (DL)** -Luminaires are suitable for use in damp location(s). Examples of such locations include protected areas under canopies, marquees, roofed porches, and similar locations where the fixture(s) are protected from direct contact with rain, snow, or excessive moisture (such as ocean spray). Interior locations include areas subject to moderate degrees of moisture, such as basements and certain barns and cold storage buildings. All solder points on LED boards are conformal coated. The phosphor layer of the LEDs is free of coating to avoid hazing.

**Separate Switching (SS)** - Luminaire available with the Direct side switched separately from the Indirect side starting at the 4' nominal length and then in 2' nominal steps, i.e. 6', 8', 10', 12', etc... Luminaire is intended to be wired to the same panel/breaker (not intended for Emergency use).

\* All separately switched (non-EM) circuits within an individual luminaire, linear run, or configuration must be connected to the same branchcircuit on-site.

\* If the project requires different separate switching than outlined above please consult the factory.

**Emergency Circuit (EC)** - Available starting at 4' nominal length and then in 2' steps (i.e. 6', 8', 10', 12'...). Luminaires to have the first 4' nominal length operated on separate EM circuit by default to meet the required "Life Safety Code" (NFPA 101). If a different configuration is needed please consult the factory. Luminaires with EC option compliant to UL 924. EC luminaires are intended to be wired to separate panels/breakers for emergency use.

**Joiner System** - standard

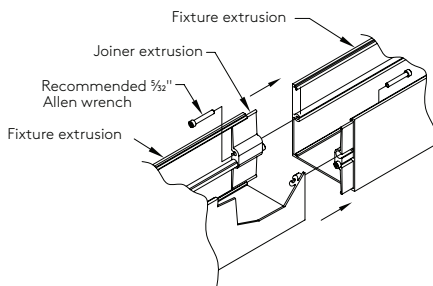



M100 My White  
LED Direct/Indirect



Photometry

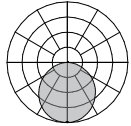

LW - LED Optimized White Lens				
Light Engine	Lumens per 4 foot	Lumens per foot	Input watts per foot	lm/W
1A32	2592	648	8.6	75

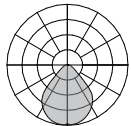

MI - Clear Lens with Microprism Inlay				
Light Engine	Lumens per 4 foot	Lumens per foot	Input watts per foot	lm/W
1A32	2696	674	8.6	78

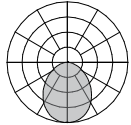

NB - LMO Symmetric (Direct Only)				
Light Engine	Lumens per 4 foot	Lumens per foot	Input watts per foot	lm/W
1A32	2411	603	8.6	70

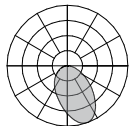

A2 - LMO Asymmetric 20° Wall Washer (Direct Only)				
Light Engine	Lumens per 4 foot	Lumens per foot	Input watts per foot	lm/W
1A32	2436	609	8.6	71

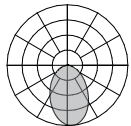

A5 - LMO Asymmetric 5° Wall Grazer (Direct Only)				
Light Engine	Lumens per 4 foot	Lumens per foot	Input watts per foot	lm/W
1A32	2488	622	8.6	72

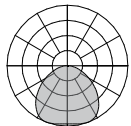

BW - LMO Batwing (Direct Only)				
Light Engine	Lumens per 4 foot	Lumens per foot	Input watts per foot	lm/W
1A32	2255	564	8.6	66

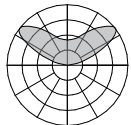

WB - Wide LMO Batwing (Indirect Only)				
Light Engine	Lumens per 4 foot	Lumens per foot	Input watts per foot	lm/W
1A32	3629	907	8.6	111

M100 My White Direct	
Lens Multiplier	
LW	1.00
MI	1.04
NB	0.93
A2	0.94
A5	0.96
BW	0.87
WB	1.28

Note: Due to the amount of variation of lens/distribution options possible, please import and align the individual direct and indirect IES files and group within the photometric program you are using.

CCT and CRI multipliers apply to the photometry, IES files, and per foot values listed on page 1 (light engine).

Lens multipliers supplied for per foot values listed on page 1 (light engine).

M100 My White  
LED Direct/Indirect



**Photometry**

This photometry can be used for all CCTs when utilizing the constant lumen level (CLL) curve for My White. For other outputs, please consult the factory.

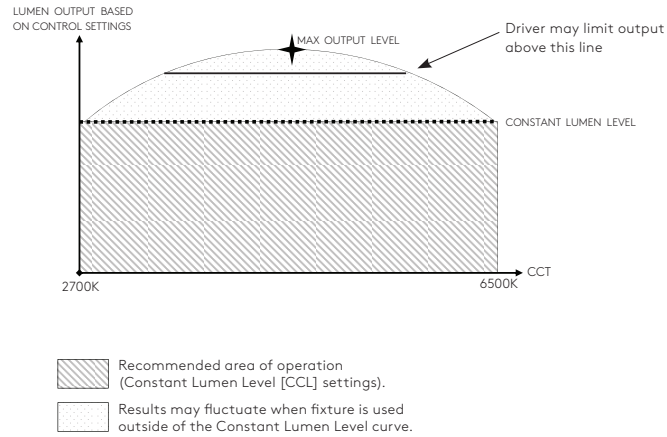

**My White and the Circadian Rhythm** – Humans have an internal clock that affects everything from sleep patterns to productivity to health. This clock is called the circadian rhythm. As humans evolved in the days before electric lighting, they had natural exposure to various levels (both color temperature and intensity) from the sun. By adjusting electric lighting to mimic the natural hue and intensity of the sun, it can help restore the body to a natural state. Various studies have shown that this can help with alertness, behavioral issues, and productivity. The Selux proprietary My White technology allows you to adjust both the amount and color of your light, creating a comfortable environment for offices, educational facilities, hospitality, or any other installation where varying light could benefit the occupants. Set up the My White luminaires to a whole building solution, and you could create an automatic adjustment to the light to mimic daylight.