

Lighting Services Inc

LumeLEX Series

# LX2088 • 120/277V • LUMENETIX-ARAYA • 32MM



**Elegant fixture designed specifically for the most demanding architecture applications.**

- Designed for the Lumenetix-araya Color Tuning LED module up to 67 Watts
- Extremely tight color consistency (less than 2 MacAdam Ellipses,  $\pm 0.002$  DUV), (2000K to 6000K at 2 SDCM)
- System efficiency up to 63 lumens/watt
- On board closed loop feedback compensates each channel for thermal and optical depreciation.
- 50,000 hour life to 70% lumen output, L70 at 95°F max ambient
- Tunable white from 1650K to 8000K
- Full color tuning and gradients of saturated colors
- Color Rendering Index (CRI) of 90+ from 2000K to 6000K
- 4250 produced lumens
- Tested to LM79 and LM80 Protocols
- Choice of dimming down to 1%. Compatible with 2 zones for 0-10V
- 0-10V with the ability to control intensity and CCT simultaneously
- Compatible with DMX and RDM
- Uses the following four DMX channels: Dimming, CCT, Saturation, and Hue
- Field interchangeable optics (24°- 55°) modify the beam spread distribution
- Accessory holder accepts up to three size-C LSI filters and accessories
- Finishes: LSI Black, White, and Silver
- Fixture weight: 8 lbs
- All modules are field replaceable
- Fixed center stem
- Maximum stem length is 12"

## FIXTURE PART NUMBERS

Please review the **ORDERING INFORMATION** section on the next page as well as the **MOUNTING OPTIONS** on page 3 to create a part number for each fixture that specifies the following:

- LED Module
- LED Rating
- Color Temperature
- Optic - mm/beam spread
- Fitting/Controls (Dimming)
- Voltage
- Finish

### PART NUMBER

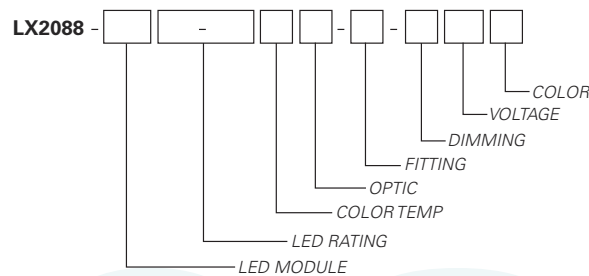

Example Part Number: **LX2088-L3250-90DWX2-CT1-10120W** is a fixture with a Lumenetix-araya 32mm LED module, 5000 Lumen/90 CRI/67 Watt LED rating, Dynamic White (1650 - 8000K) Color Temperature, 111mm 24° Optic, CT1 CONTROLTrack fitting with 0-10V compatible control gear, 120V and a White finish.

Lighting Services Inc

LumeLEX Series

# LX2088 • 120/277V • LUMENETIX-ARAYA • 32MM

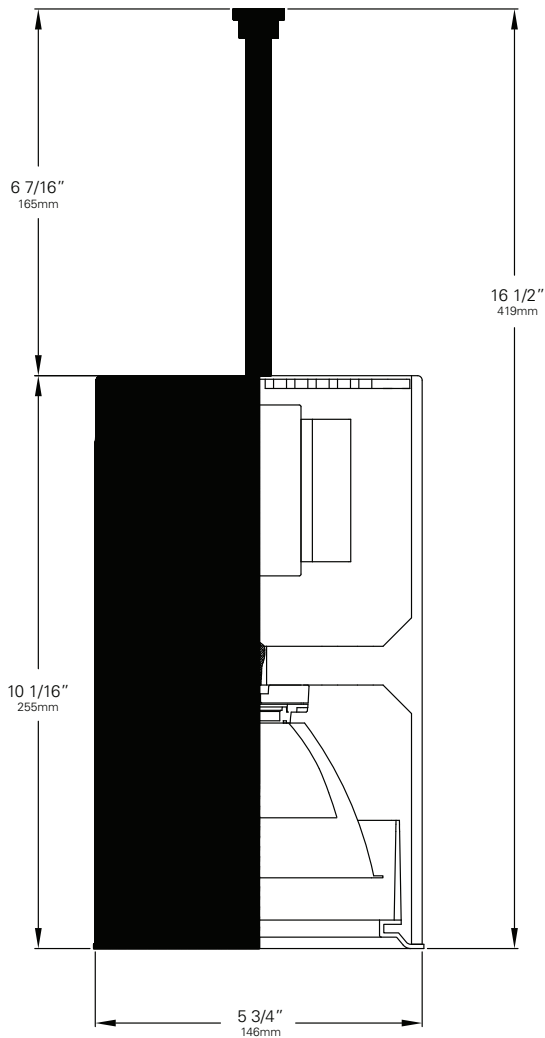

## ORDERING INFORMATION

### Base Fixture Model

- LX2088-L32

### LED Rating (Lumens/CRI/Wattage)

- 50-90 = 5000/90/67

### Color Temperature

- DW= Dynamic White 1650-8000K\*
- CO= Full Color and Dynamic White 1650-8000K (DMX Dimming only)

### Optic

- X2 = 111mm/ 24°
- X4 = 111mm/ 40°
- X5 = 111mm/ 55°

### Fitting/Controls (Dimming)

- CT1-10 = CONTROLTrack Fitting & 0-10V (1%)\*
- CT1-DX = CONTROLTrack Fitting & DMX (<1%)\*
- 5A-10 = Canopy Fitting & 0-10V (1%)\*
- 5A-DX = Canopy Fitting & DMX (<1%)\*

### Voltage

- 120 = 120V
- 230 = 220-240V
- 277 = 277V

### Finish

- B = Black
- W = White
- S = Silver

### Example Part Number:

**LX2088-L32 50-90 DW X2- CT1-10 120 W**

FIXTURE MODEL      LED RATING      COLOR TEMP      OPTIC      FITTING/ DIMMING      VOLTAGE      FINISH

### Other Options (Consult Factory):

- Custom Stems, specify length (4" - 12")
- Custom color, RAL palette

\*0-10V available in Dynamic White only.

Lighting Services Inc

LumeLEX Series

# LX2088 • MOUNTING OPTIONS

**FITTING**

**SIDE VIEW**

**STEM LENGTH VIEW**

**CT1 CONTROLTrack Fitting**

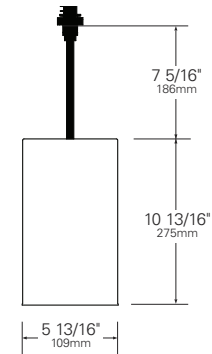
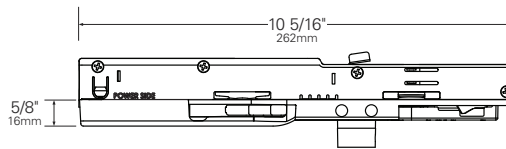

**5A Canopy Fitting**

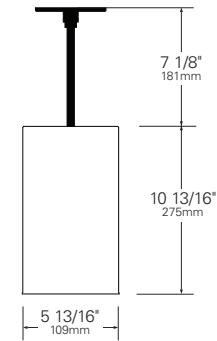
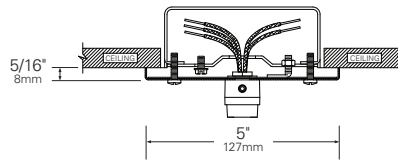

sixteen5hundred	Project 21-12877-4 Date 6/24/2021 Tunable White   Color Tuning	Catalog Number LX2088-L19 50-90 CO X2 CT1-DX 120 S	Type
	Submitted By 16500, INC	Notes	

# LX2088 • PERFORMANCE

The performance characteristics of the LumeLEX family of products can be customized based on the LED module and the optic (reflector) selected.

Each available LED module is defined by four characteristics – module type (dynamic white vs full color), control type (0-10V and DMX), the power that it uses (watts), and its “available lumens.” Note that available lumens is a theoretical value that represents the light output of the module on its own – no fixture or optic attached.

In the LSI part number, the LED module is specified with a letter and a number that immediately follow the product series number. For example, in the part number LX2088-L3250-90DWX2-CT1-10120W, the “50-90CO” represents a 32mm Lumenetix-araya module with an output of 5000 Lumens, a minimum CRI of 90, with Dynamic White color temperature and power usage of 67 Watts.

The available optics (reflectors) are characterized by size, beam angle, and in some cases the characteristics of the field angle (narrow or wide). The optic is specified by the two characters that follow the LED designation in the part number. For example, the “X2” in LX2088-L3250-90DWX2-CT1-10120W is a 111mm diameter optic that has a 24-Degree beam.

Additional parameters, such as Center Beam Candle Power (CBCP), Delivered Lumens, and Efficiency (Lumens per Watt) are all shown in a table that is organized by LED module and optic combination.

CBCP = Center Beam Candle Power			
LED Module	Optic (Reflector)		
Lumens/CRI/Wattage	X2	X4	X5
5000/90/67	26150	10750	5850

Delivered Lumens			
LED Module	Optic (Reflector)		
Lumens/CRI/Wattage	X2	X4	X5
5000/90/67	4000	4150	4250

Efficacy = Lumens Per Watt			
LED Module	Optic (Reflector)		
Lumens/CRI/Wattage	X2	X4	X5
5000/90/67	60	62	63

*Absolute range of values are +/- 10% of typical value, and are for all color temperatures*

LED Module Lumens/CRI/Wattage SKU Code	5000/90/60 50-90
Nominal Fixture Power (+/- 20%), Watts	67
Maximum Inrush Current, Amps	10
Minimum Power Factor	0.92

*Inrush current is instantaneous current drawn by the LED only when fixture is initially powered on or instantaneously changed from full dim to full bright. For more details see Dimming Application Sheet, IS-0119.*

# LX2088 • OPTICS

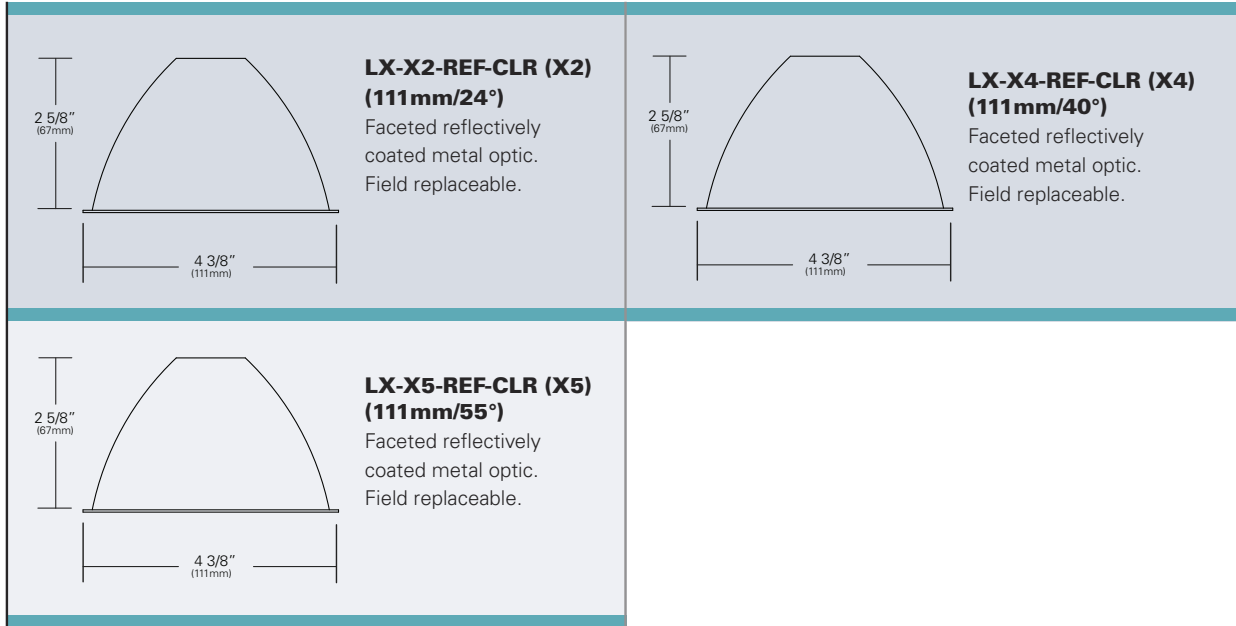

# LX2088 • PHOTOMETRIC DATA

LED RATING: 50-90

**X2- 111mm DIA Optic**

Beam Spread (minimum) **24°**  
Center Beam Candlepower **26150**  
CRI **90**

**X4-111mm DIA Optic**

Beam Spread (minimum) **40°**  
Center Beam Candlepower **10750**  
CRI **90**

**X5- 111mm DIA Optic**

Beam Spread (minimum) **55°**  
Center Beam Candlepower **5850**  
CRI **90**

LED RATING: 50-90

All Max. Footcandles at 0° Beam Axis

	X5 55°	X4 40°	X2 24°
5850	10750	26150	
1463	2688	6538	
650	1194	2906	
366	672	1634	
234	430	1046	
163	299	726	
119	219	534	
91	168	409	
72	133	323	
59	108	262	
48	89	216	
41	75	182	
35	64	155	
30	55	133	
26	48	116	
23	42	102	
20	37	90	
18	33	81	
16	30	72	
15	27	65	
13	24	59	
12	22	54	
11	20	49	
10	19	45	
9	17	42	

All Distances in Feet

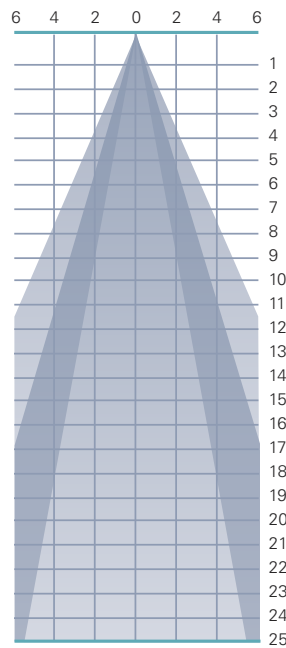

Photometric Data based on LED Rating: 50-90 (5000 Lumens/90CRI/67watts)

# LX2088 • ACCESSORIES

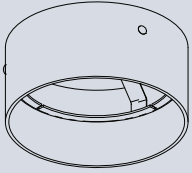

### HOOD-EXT-LX84-NXB-X

Cylindrical metal hood controls spill light and glare. Does not include cross baffle. Specify finish.

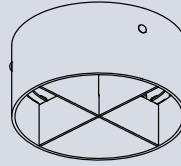

### HOOD-EXT-LX84-WXB-X

Cylindrical metal hood controls spill light and glare. Includes cross baffle. Specify finish.



### SPREAD LENSES AND BEAM SOFTENER

No.	Description	% of Light Transmission
C990	Spread Lens/Clear	83 (5°X 50°)
C992	Spread Lens/Clear	85 (5°X 30°)
C995	Spread Lens/Clear	83 (50°X 50°)
C996	Spread Lens/Clear	86 (45°X 50°)
C998	Beam Softener/Clear	80 (45°X 45°)



### <sup>1</sup>LIGHT BLOCKING SCREENS C

Stainless steel mesh screens used alone or in combinations will block from approximately 20% to 90% of the transmitted light without changing color temperature of the light.

No.	% of Light Blocked
C801S	20
C802S	30
C803S	40



### LOUVER HEX C

1/8" thick Hexcell black metal louver used for thin profile. Black finish.

1. Figures vary based upon LED Module/Optic being used and relationship of screen(s) to LED Module/Optic and to each other.

Lighting Services Inc

# COLOR MEDIA

## COLOR FILTERS

As the foremost innovator in accent lighting, LSI offers a complete range of permanent fade-free glass color filters, which are available in nine stock diameters. All glass color filters are rimmed in a seamless aluminum ring and are slotted for heat expansion.



Size	Diameter	LSI Fixture Series	No.	Color	% of Light Transmission
AAA	2 3/8"	LumeLEX® 2020/2030/2031/2038, SSLCX16, SSL260, LumeLEX MAR-S	902	Medium Pink	36
ZM	2 13/16"	LZ ZOOM	903	Deep Pink	37
AA	3"	LumeLEX® 2044, LumeLEX 2048	904	Flesh Pink	73
A	3 1/2"	LumeLEX® 2060, SSL230, SSLCX30, SSLGR30CL	906	Pale Lavender	14
B	4 1/4"	LumeLEX® MAR-L	907	Surprise Pink	19
C	4 3/4"	290, LumeLEX® 2084, LumeLEX® 2088, SSL238, SSLCX36, SSLCX38, SSLGR38CL	908	Lilac	21
			910	Warm Red	10
			911	Strawberry	6
			912	Ruby	4
			913	Magenta	1
			914	Light Amethyst	25
			915	Medium Amethyst	16
			916	Deep Amethyst	4
			917	Olive	18
			918	Light Green	68
			920	Medium Green	25
			921	Deep Green	7
			922	Silver green	65
			923	Yellow Green	49
			924	Emerald Green	12
			925	Light Turquoise	68
			926	Medium Turquoise	40
			927	Deep Turquoise	17
			928	Light Blue	34
			930	Medium Blue	3
			932	Daylight	59
			933	Gene Moore Blue	18
			936	Grey	56
			937	Light Blue Green	17
			939	Light Amber	68
			940	Medium Amber	48
			941	Deep Amber	43
			942	Straw	78
			943	Gold	87
			944	Canary Yellow	84
			945	Lemon	81
			946	Pumpkin	32
			947	Tangerine	20
			948	Orange	23
			949	Pink Gold	54
			950	Bronze	48
			951	Brass	11
			952	Autumn Tan	11
			953	Leaf Brown	19
			954	Butter Pecan	3
			955	Toasted Almond	1

Notes:

1. Values given are approximate due to slight variations in glass color and thickness.



# COLOR MEDIA

## DICHROIC COLOR FILTERS

In addition to our complete line of glass color filters, LSI now offers dichroic glass color filters that achieve purer, more saturated, richer color by selective wavelength transmission. Since these filters reflect rather than absorb the unwanted color wavelengths, a higher intensity of colored light can be obtained with fewer or lower wattage fixtures. In addition, this selective transmission allows for very accurate color matching from filter to filter.

All standard LSI filter sizes are available in a wide palette of well chosen dichroic colors that can be used with all LSI fixtures that accept accessories.

LSI dichroic glass color filters have the added benefit of being rimmed for extra durability to allow for frequent usage without fear of breakage or edge chipping.

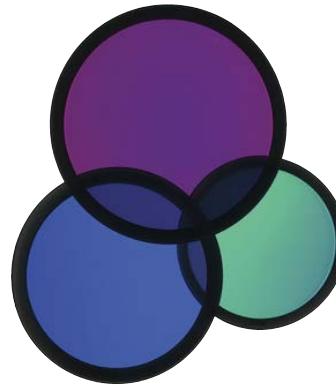

Size	Diameter	LSI Fixture Series	Technical Data	No.	Color	% of Light Transmission
AAA	2 3/8"	LumeLEX® 2020/2030/2031/2038, SSLCX16, SSL260, LumeLEX MAR-S	Dichroic color filters are created in a vacuum chamber by multi-layer vapor deposits of different minerals onto low expansion, chemically resistant Borosilicate glass.	2001	Light Pink	69
ZM	2 13/16"	LZ ZOOM	Deposits are made in alternating layers of varying microscopic thickness which allow very narrow color wavelengths to be selectively transmitted and all other wavelengths to be reflected.	2002	Medium Pink	43
AA	3"	LumeLEX® 2044, LumeLEX 2048	LSI does not recommend using dichroic color filters with lamps or fixtures that have beam spreads greater than 40° because a secondary color aura is created by the wide angular transmitted wavelengths that are different than the desired color wavelength.	2003	Hot Pink	11
A	3 1/2"	LumeLEX® 2060, SSL230, SSLCX30, SSLGR30CL	Since there is mainly transmission and reflection of the color wavelengths by the dichroic filter and very little absorption, the dichroic filter can be used with many high temperature lights that normally would not accept color filters.	2004	Pale Pink	55
B	4 1/4"	LumeLEX® MAR-L		2010	Deep Magenta	29
C	4 3/4"	290, LumeLEX® 2084, LumeLEX® 2088, SSL238, SSLCX36, SSLCX38, SSLGR38CL		2011	Lavender	24
				2012	Vivid Magenta	31
				2013	Lavender Accent	48
				2014	Lilac	37
				2015	Purple Fusion	12
				2020	Sky Blue	39
				2021	Sea Blue	39
				2022	Cyan	33
				2023	Light Blue Green	30
				2024	Primary Blue	24
				2025	Medium Red Blue	15
				2026	Deep Purple	16
				2027	Peacock Blue	53
				2028	Mediterranean Blue	20
				2029	Boost Blue	51
				2040	Light Yellow Green	64
				2041	Fern Green	47
				2042	Turquoise	35
				2043	Primary Green	31
				2044	Industrial Green	64
				2050	Yellow	80
				2051	Amber	71
				2052	Amber Blush	38
				2053	Bastard Amber	71
				2054	Goldenrod	63
				2055	Bright Straw	56
				2060	Medium Orange	51
				2061	Orange	44
				2070	Flame Red	27
				2071	Primary Red	25