

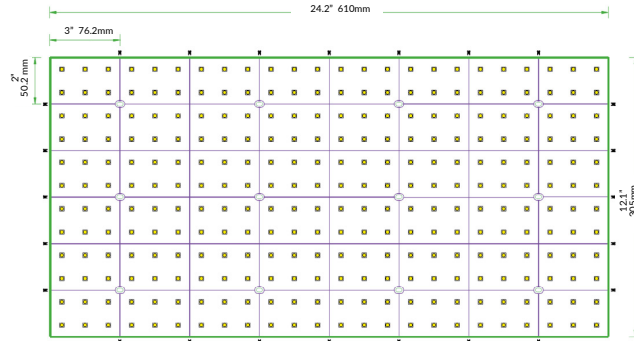

LLI ARCHITECTURAL LIGHTING

# COLOR CHANGING FLEX SHEET

RGBW / Flexible LED Sheet / 24V

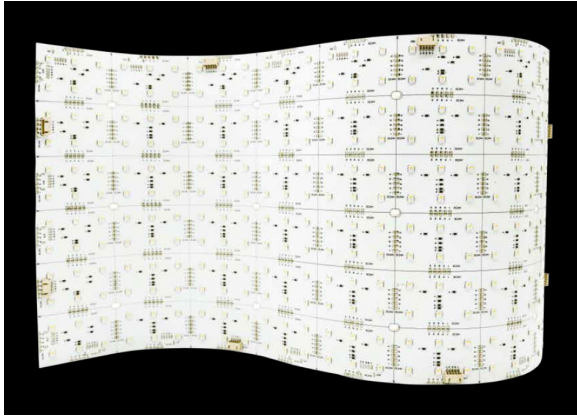

## TECHNICAL INFORMATION

|                  |   |
|------------------|---|
| WATTAGE          | 46.0W per sheet   |
| IP RATING        | IP20 - dry location   |
| TOTAL OUTPUT     | RGB30K - 2200 lm<br>Red - 296 lm<br>Green - 845 lm<br>Blue - 171 lm<br>3000K - 1034 lm      |
| INPUT VOLTAGE    | 24VDC   |
| CRI              | 90+   |
| CUT LENGTH       | Cuttable every 8 LEDs or 2" x 3" sections   |
| MAXIMUM RUN      | 2 sheets in series connection   |
| SHEET DIMENSIONS | 24" W x 12" H (610mm x 305mm)   |
| ADHESIVE BACKING | Yes - 3M™ mounting adhesive tape  |
| LIFESPAN         | 50,000 hrs  |
| WARRANTY         | 3 year limited  |
| POWER SUPPLY     | Compatible with all non-dimmable 24VDC power supplies - see power supply section of website |

### RECOMMENDED APPLICATIONS:

- Back-lit graphics
- Sign lighting
- Retail displays

### CONNECTORS:

One (1) power connector (length 48") and two (2) connector cables are included with each sheet. Do not exceed 6A.



Power Connector - 48"

Part Number: LLI-FS-PWR5-48IN



Connector Cable - 3"

Part Number: LLI-FS-CON5-3IN

### MOUNTING OPTIONS:

See page 2 for full mounting details. 3M™ mounting adhesive included on the back of sheet. Holes available for securing with screws.

## PART NUMBER BUILDER / ORDERING GUIDE

Example part number: LLI-FS46.0W-20-R30-24V

|             |           |       |         |
|-------------|-----------|-------|---------|
| SERIES      | IP RATING | COLOR | VOLTAGE |
| LLI-FS46.0W | 20        | R30   | 24V     |

# COLOR CHANGING FLEX SHEET

RGBW / Flexible LED Sheet / 24V

## INSTALLATION / MOUNTING OPTIONS

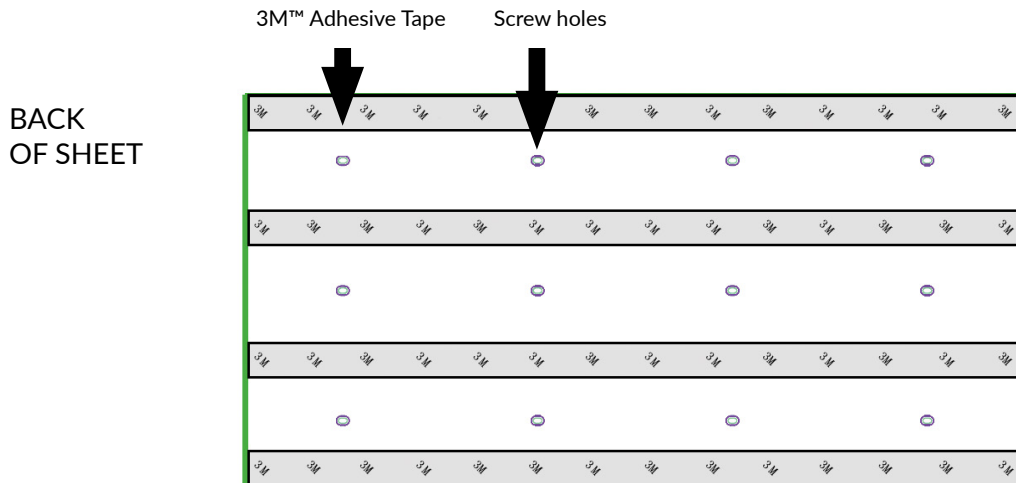
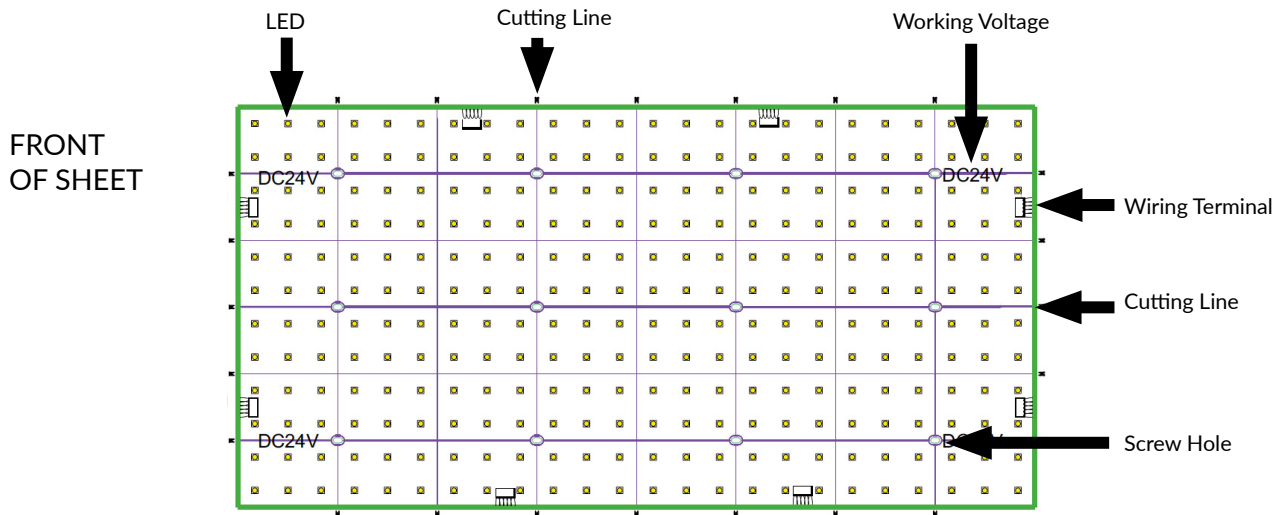

Screw holes (detail)

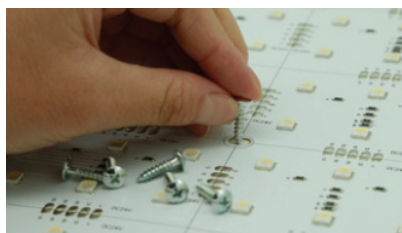
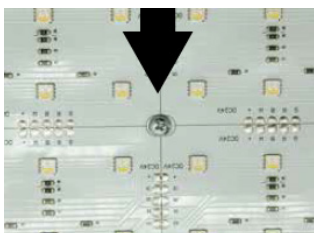

# COLOR CHANGING FLEX SHEET

RGBW / Flexible LED Sheet / 24V

## WIRING DIAGRAM

**NOTE:** Polarity is crucial for correct operation. Note the "input" and "output" labeling on each terminal before connecting.

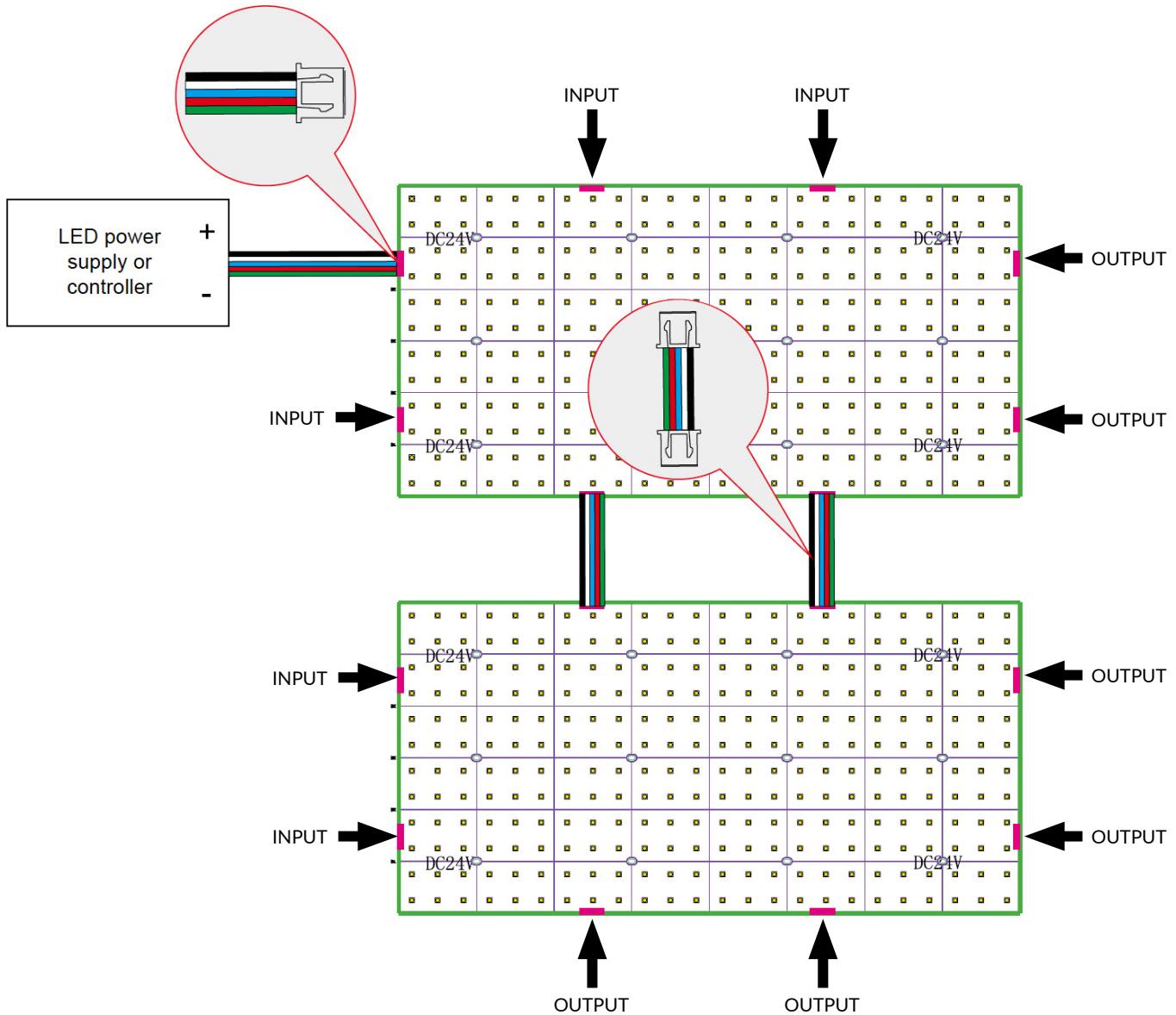

# COLOR CHANGING FLEX SHEET

RGBW / Flexible LED Sheet / 24V

PHOTOMETRY & TESTING

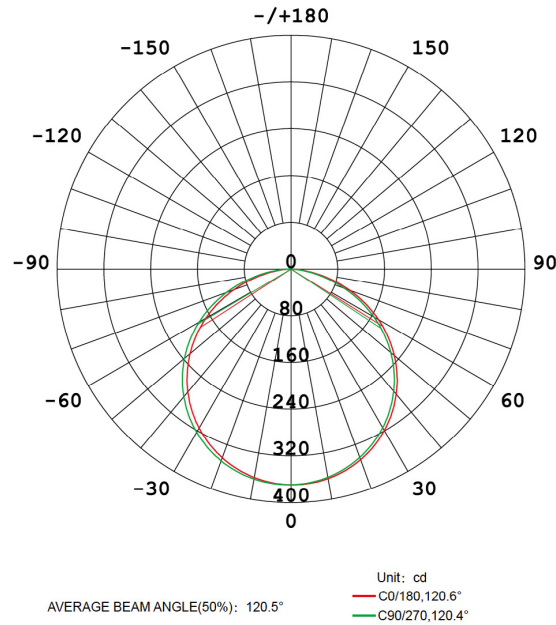

Flux Out: 798.0lm

| Height | Eavg, Emax       | Beam Angle: 120.00° | Diameter |
|--------|------------------|---------------------|----------|
| 1cm    | 846664,4418079lx |                     | 3.46cm   |
| 2cm    | 211666,1104520lx |                     | 6.93cm   |
| 3cm    | 94074,490898lx   |                     | 10.39cm  |
| 4cm    | 52917,276130lx   |                     | 13.86cm  |
| 5cm    | 33867,176723lx   |                     | 17.32cm  |
| 6cm    | 23518,122724lx   |                     | 20.78cm  |
| 7cm    | 17279,90165lx    |                     | 24.25cm  |
| 8cm    | 13229,69032lx    |                     | 27.71cm  |
| 9cm    | 10453,54544lx    |                     | 31.18cm  |
| 10cm   | 8467,44181lx     |                     | 34.46cm  |