

BeveLED Mini® Infinite Color+® - B3RC-FC1

3" Round Deep Regress Downlight

Field Convertible from Trimless or Millwork to Trimmed

Trimmed - B3RCF-FC1



Trimless - B3RCL-FC1



usailighting.com/infinitecolormini

Millwork - B3RCM-FC1



BeveLED Mini Infinite Color+ - the smallest member of our iconic BeveLED family to offer full color + tunable white light flexibility. Access to a wide variety of perfect architectural whites, saturated colors, neutrals, and pastels are possible with DMX controls. Infinite opportunities abound for residential, hospitality and retail lighting applications, and any project requiring full color and white light flexibility.

FEATURES

- Full color and white light flexibility
- Dry/damp/wet location rated for showers
- Field convertible from trimless or millwork to trimmed

DEEP REGRESS DOWNLIGHT PERFORMANCE DATA (Projected)

DELIVERED* PERFORMANCE:	Infinite Color +	
	White Light Channel Only	Multi Channel Output
Wattage	17W	18W
Source Lumens:	1100	1200
Lumens Per Watt:	39	40
Delivered Lumens:	675	725

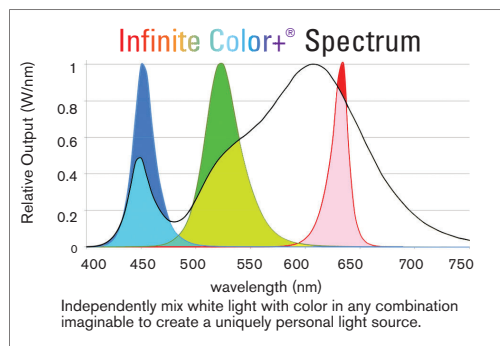

BeveLED Mini® Infinite Color+® - B3RC-FC1

3" Round Deep Regress Downlight

1. Specify fixture part number and options.

B3RC __	18FC1		SF				RM	
BeveLED Trim Style	Wattage Options	Beam Options	Lens Options	Bevel Trim Finish Options	*Flange/ Millwork Collar Finish	Housing Options	Remote Dimming Driver	Accessories (Optional)
F Trimmed with Flange (use with all materials) L Trimless Spackle-in (use with sheetrock and plaster only) M Millwork Knife-Edge (use with wood and stone)	18FC1 18W LED	45 55° beam 55 55° beam	SF Solite Frosted	WH White	WH White	NC1 New Construction All-in-One NCPP Chicago Plenum NCIC Insulation Contact Rated / Airtight	RM Remote Dimming Driver, specify remote power supply in table below	CB27 27" C-Channel Bars CB52 52" C-Channel Bars
				SC Conduit Silver	SC Conduit Silver			
				GR Grey	GR Grey			
				BL Black	BL Black			
				BZ Bronze	BZ Bronze			
				PR Primer Finish	PR Primer Finish			
				AC Clear Matte Anodized	AC Clear Matte Anodized WH White GR Grey BL Black BZ Bronze			
				AB Piano Gloss Black	AB Piano Gloss Black WH White GR Grey BL Black BZ Bronze			
				RAL Custom Color Specify RAL #	RAL Custom Color Specify RAL #			

USAI Power Supply Must Be Specified

TRIM FINISH OPTIONS



Custom colors and primer finish also available

*Leave blank for Trimless

2. Specify Remote Power Supply

RPB-01	18FC1	UNV	D23X1	
Remote Power Supply	Fixture Wattage	Voltage	Remote Dimming Driver Type*	Cabling Option <i>Select one</i>
RPB-01 BeveLED Mini Infinite Color+ Remote Power Supply	18FC1 18W LED	UNV 120V - 277V	D23X1 EldoLED DMX 0.1% dimming, manual addressing using RDM protocol, 8 bit *Requires remote enclosure by others, minimum size 9"L x 4"W x 2"H	RJ RJ45 Jacks WR Manual Wire Splice Connection

NOTE:
Remote Power Supplies Require Enclosures by Others. See Page 6 for Details.

BeveLED Mini® Infinite Color+® - B3RC-FC1

3" Round Deep Regress Downlight

Trimmed - B3RCF-FC1

TRIM DETAILS

Trimmed - B3RCF-FC1

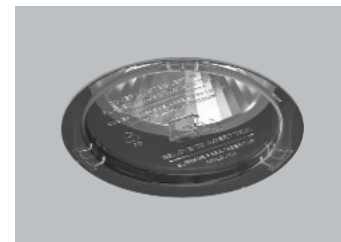

Clear acrylic overspray protector provided standard with every housing to keep out dust and contaminants during construction. Allows for use as work light.

HOUSING OPTIONS

New Construction Housing - NC1
Insulation-Contact Rated - NCIC
Chicago Plenum Rated - NCCP

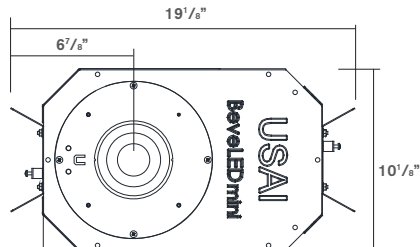
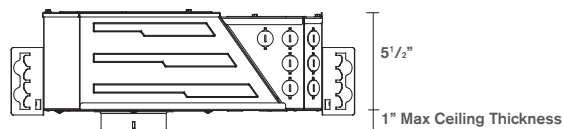

BeveLED Mini® Infinite Color+® - B3RC-FC1

3" Round Deep Regress Downlight

Trimless - B3RCL-FC1

TRIM DETAILS

Trimless - B3RCL-FC1

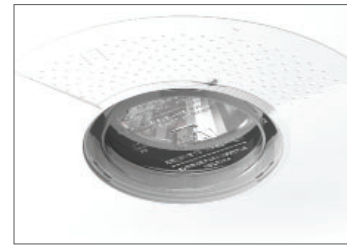
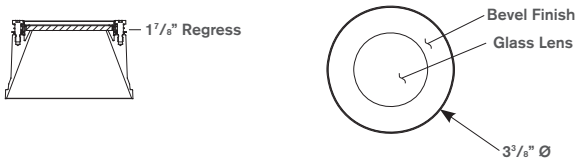

Clear acrylic overspray protector provided standard with every housing to keep out dust and contaminants during construction. Allows for use as work light.

HOUSING OPTIONS

New Construction Housing - NC1
Insulation-Contact Rated - NCIC
Chicago Plenum Rated - NCCP

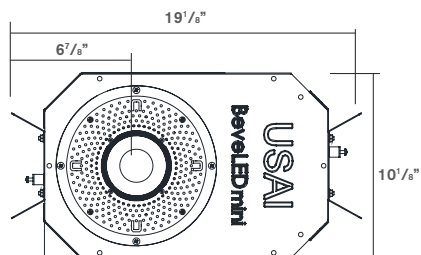
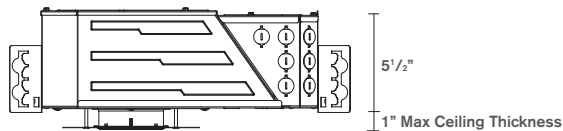

BeveLED Mini® Infinite Color+® - B3RC-FC1

3" Round Deep Regress Downlight

Millwork - B3RCM-FC1

TRIM DETAILS

Millwork - B3RCM-FC1

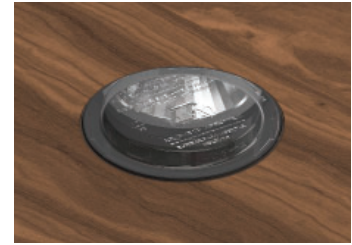
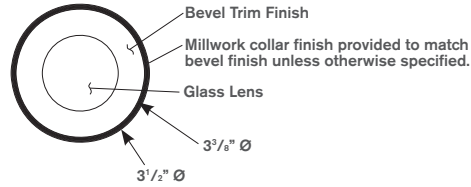
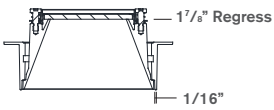

Clear acrylic overspray protector provided standard with every housing to keep out dust and contaminants during construction. Allows for use as work light.

HOUSING OPTIONS

New Construction Housing - NC1
Insulation-Contact Rated - NCIC
Chicago Plenum Rated - NCCP

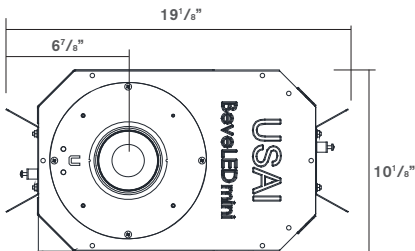
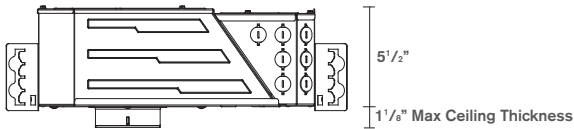

BeveLED Mini® Infinite Color+® - B3RC-FC1

3" Round Deep Regress Downlight

BEVELED MINI INFINITE COLOR+ SPECIFICATIONS

FIELD REPLACEABLE LED LIGHT ENGINE

is serviceable through the aperture with a Philips screwdriver. All USAI Lighting light engines feature industry-leading color consistency.

REMOTE LOCATION DRIVER

BeveLED Mini Infinite Color+ is supplied with quick connects for use with remotely located driver and requires 8-bit communication controls; contact USAI factory for 16 bit driver options. Driver is provided separately for remote location on site, enclosure to be provided by others. Remote dimming driver power supply option must be clearly specified in the "RP" table. Remote power supplies require enclosures by others that meet local codes and must be located in an accessible service panel within 100ft of the light fixture; see remote driver table below for coordination of enclosure sizes and wire gauges required. All dimming drivers comply with IEEE C62.41 surge protection.

Remote Power Supply Requirements and Wiring Diagrams Note: Must be wired in homeruns per wiring diagram "A" below.

1 Fixture Maximum Per Power Supply.

Remote Power Supply	Dimming Option	Wire Gauge Required*	Minimum Enclosure Size Required (by others)
RPB-01-18FC1	UNV-D23X1 EldoLED, 8 bit, DMX, 0.1%	18/16	9" W x 4" L x 2" H

* Wire gauge 18/16 = Maximum distance from light fixture to remote power supply is 100' using 16 gauge wire, 50' using 18 gauge wire.

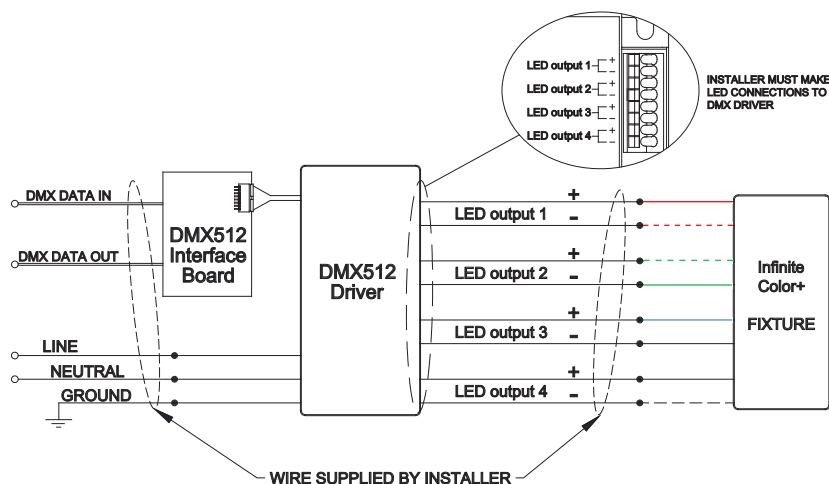

CABLING: Data cables must be run in series between fixtures. Choose your preferred method of connection when specifying. To avoid signal transmission problems, a DMX link terminator should be used in the last fixture in a series on a given DMX bus. NOTE: Data communication cables and AC power lines must not be run in the same conduit.

• **RJ Cabling Option:** If the RJ cabling option is specified, the remote power supply is provided with a DMX interface board that has RJ45 jacks for data connection with CAT5 cable terminated with RJ45 connectors. A link termination dip switch is provided at the connector board; no separate link termination device is required.



• **WR Cabling Option:** If the WR cabling option is specified, the remote power supply is provided with a DMX interface board with terminal blocks for wires to be manually spliced for data connection. A link termination dip switch is provided at the connector board; no separate link termination device is required. The data cable used must meet the following requirements:

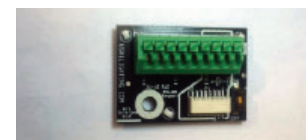

- type: shielded, 2-conductor twisted pair
- maximum capacitance between conductors: 30 pF/ft
- maximum capacitance between conductor and shield: 55 pF/ft
- maximum resistance: 0.02 ohms/ft
- normal impedance: 100-140 ohms
- conductive core: 24 AWG is recommended

NOTE: If 3-wire data cables are preferred, we suggest a Belden 9841 or equivalent cable which meets the specifications for EIA RS-485 applications. Do not use standard microphone cables: they cannot transmit DMX512 data reliably over long distances.

BeveLED Mini® Infinite Color+® - B3RC-FC1

3" Round Deep Regress Downlight

BEVELED MINI INFINITE COLOR+ SPECIFICATIONS

HOUSING

All BeveLED Mini fixtures are field-flexible which allows for field changes from trimless or millwork to trimmed with a simple components change with parts from USAI. Housings are fabricated of 20 ga. steel construction and are supplied with quick connects and wire connections for use with remotely located driver. Driver is provided separately for remote location on site, enclosure to be provided by others.

MOUNTING

B3RCF overlap flange fixtures are designed for use in sheetrock, acoustical ceiling tile, and many other ceiling materials. B3RCL trimless fixtures are provided with a spackle collar and are designed for use in sheetrock/mud-in ceiling applications. B3RCM millwork fixtures are provided with a millwork collar and are designed for use in wood/millwork and stone construction applications. Butterfly brackets and adjustable nailer bars extendible from 14" to 24" centers with integral nails are provided for attachment to building structure. C-channel bars are optionally available for acoustical ceiling applications.

FIXTURE WEIGHT

NC1, NCIC, and NCCP housings weigh 11 lbs.

WARRANTY

Based on IESNA LM80-2008, BeveLED has a 50,000 hour rated life at 70% lumen maintenance (L70). USAI Lighting Warranty covers replacement parts for 5 years from date of shipment. Ambient temperatures at fixture location should not exceed 40°C during normal operation.

CEILING CUT OUT

B3RCF Trimmed with Overlap Flange: 3-5/8"Ø

B3RCL Trimless Spackle-in: 4-3/16"Ø

B3RCM Millwork Knife-edge: 3-9/16"Ø

LISTINGS

Dry/Damp/Wet location. AC and AB trim finishes are dry/damp only. . UL2043 rated for use in air handling plenums. NRTL/CSA-US tested to UL standards. IBEW union made.

NOTES

- Not for use in corrosive environment
- Use of pressure washer voids warranty

PHOTOMETRICS

Consult factory or website for IES files. Tested in accordance with IESNA LM79.



IMPORTANT SAFETY INSTRUCTIONS

SAVE THESE INSTRUCTIONS

1. Keep these instructions in a safe place for future reference.
2. Only qualified electricians in accordance to local codes should install these fixtures.
3. De-energize the electrical circuit at the circuit breaker prior to installation process or servicing.
4. Make sure all connections are in accordance with the National Electrical Code and any local regulations.

**REMOTE POWER SUPPLY
WIRING GUIDE
RPB-01-FC1
RPC-01-FC1**

D23X1: EldoLED DMX dimming with manual addressing, 8-bit (Dims down to 0%)

D23X2: EldoLED DMX dimming with manual addressing, 16-bit (Dims down to 0%)

**RJ CABLE OPTION
RJ45 JACKS**

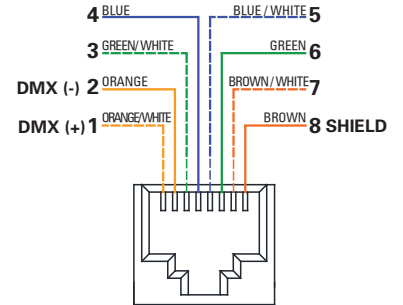
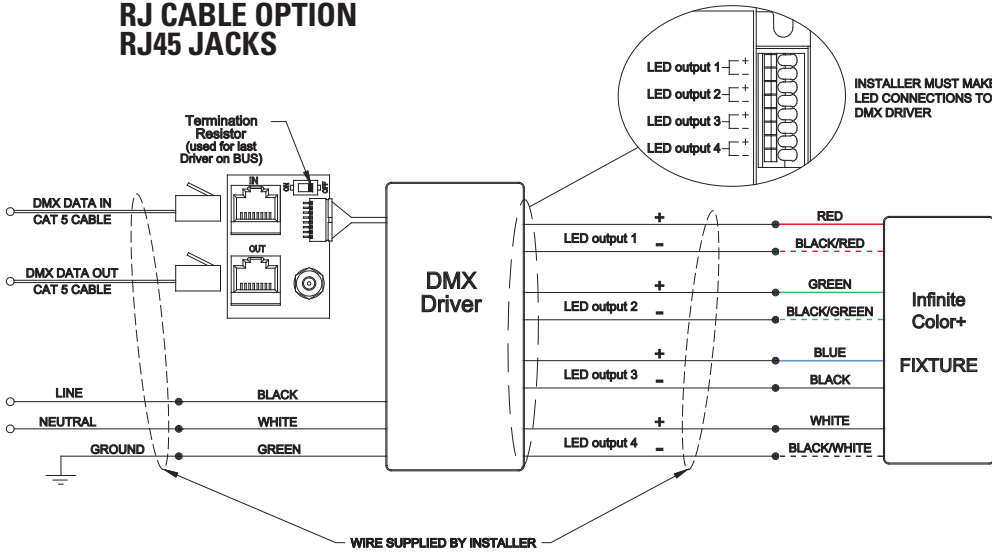

**WR CABLE OPTION
wire splice connection**

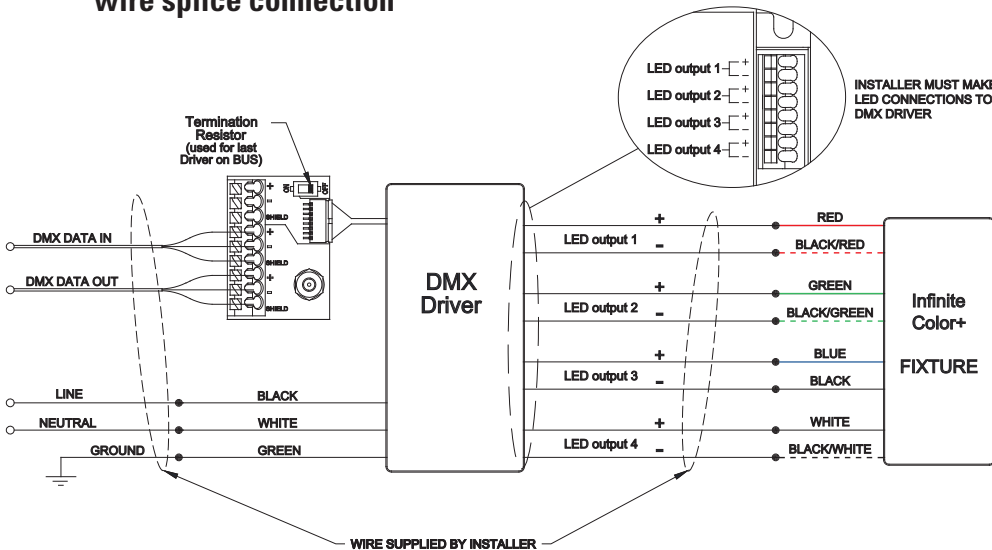

- **WR Cabling Option:** cables must be spliced connection. The data cable used must meet the following requirements:
 - type: shielded, 2-conductor twisted pair
 - maximum capacitance between conductors: 30 pF/ft
 - maximum capacitance between conductor and shield: 55 pF/ft
 - maximum resistance: 0.02 ohms/ft
 - normal impedance: 100-140 ohms
 - conductive core: 24 AWG is recommended

If 3-wire data cables are preferred, we suggest a Belden 9841 or equivalent cable which meets the specifications for EIA RS-485 applications. Do not use standard microphone cables: they cannot transmit DMX512 data reliably over long distances.



IMPORTANT SAFETY INSTRUCTIONS

SAVE THESE INSTRUCTIONS

1. Keep these instructions in a safe place for future reference.
2. Only qualified electricians in accordance to local codes should install these fixtures.
3. De-energize the electrical circuit at the circuit breaker prior to installation process or servicing.
4. Make sure all connections are in accordance with the National Electrical Code and any local regulations.

**REMOTE POWER SUPPLY
WIRING GUIDE
RPB-01-FC1
RPC-01-FC1**

DMX MUST BE DAISY CHAINED IN SINGLE LINE

CORRECT !

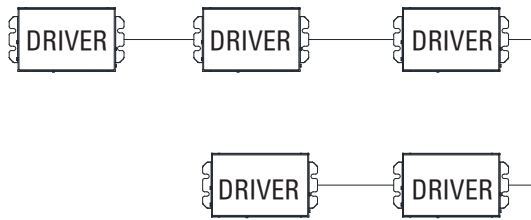

INCORRECT !

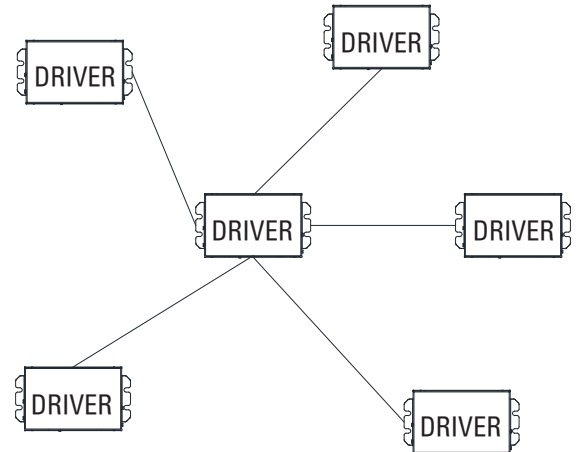

NOTES:

1. Maximum distance from light fixture to remote power supply is 100' using 16 gauge wire, 50' using 18 gauge wire.
2. Minimum enclosure size required is 9"W x 4"L x 2"H. Enclosure supplied by others.
3. Remote Power Supplies can only be used with specific fixture types. Confirm power supply compatibility on light fixture label.
4. DMX signal cable must NOT be run in same conduit as high voltage AC power lines.
5. Remote Power Supplies must be daisy chained in one serial line using Data in and Data out
6. Maximum of 32 DMX devices on single DMX bus
7. Maximum of 1600' serial communication link distance
8. To avoid signal loss, DMX signal terminator should be used on last Remote Power Supply in line. This is provided through a dip-switch on the DMX512 interface board.