

Clear Flat

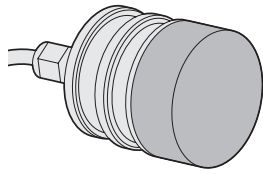

Diffused Flat

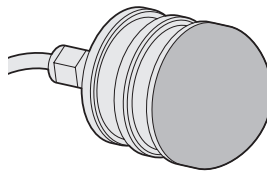

Diffused Dome

Client:

Project:

Type:

Order Code:

Quantity:



AL Dot is a direct view, RDM / DMX node, designed for low resolution graphics displays and individual dots of color. Available in a clear flat, diffused flat or diffused dome lens, it also features an internal DMX driver and all aluminum construction. It can be used indoor or outdoor and carries an IP66 outdoor rating.

SPECIFICATIONS

Color	QS (RGBW, W=3000K, RGB, 3000K, 4000K)
Available Lenses	Clear Flat, Diffused Flat or Diffused Dome
Beam Angle	120°
Max Fixtures In Series	50 units, 100' maximum length - includes fixtures + cable
Total Lumens	67 (Full on, Clear Flat)
Control	DMX / RDM
Mounting	Aluminum Attachment Ring, 1.96" (50mm) Hole Cut
Power Consumption	3W
Operating Voltage	24VDC
Lumen Maintenance	L70 @ 150,000 Hours (25° C)
Finish	Silver
Housing Material	Aluminum
Operating Temperature	-10°F to 123°F (-23°C to 50°C)
IP Rating	IP66, Wet Location
Fixture Connectors	Attached IP67 Multipin, 5 Conductor / DC + DMX Lead
Warranty	5 Years
Weight	0.77 lbs. (350 g)
Dimensions	1.97" Dia. x 2.44" (Flat), 3.43" (Dome) L - 50mm Dia. x 62 (Flat) / 87 mm (Dome) L

Certifications



ORDER CODES

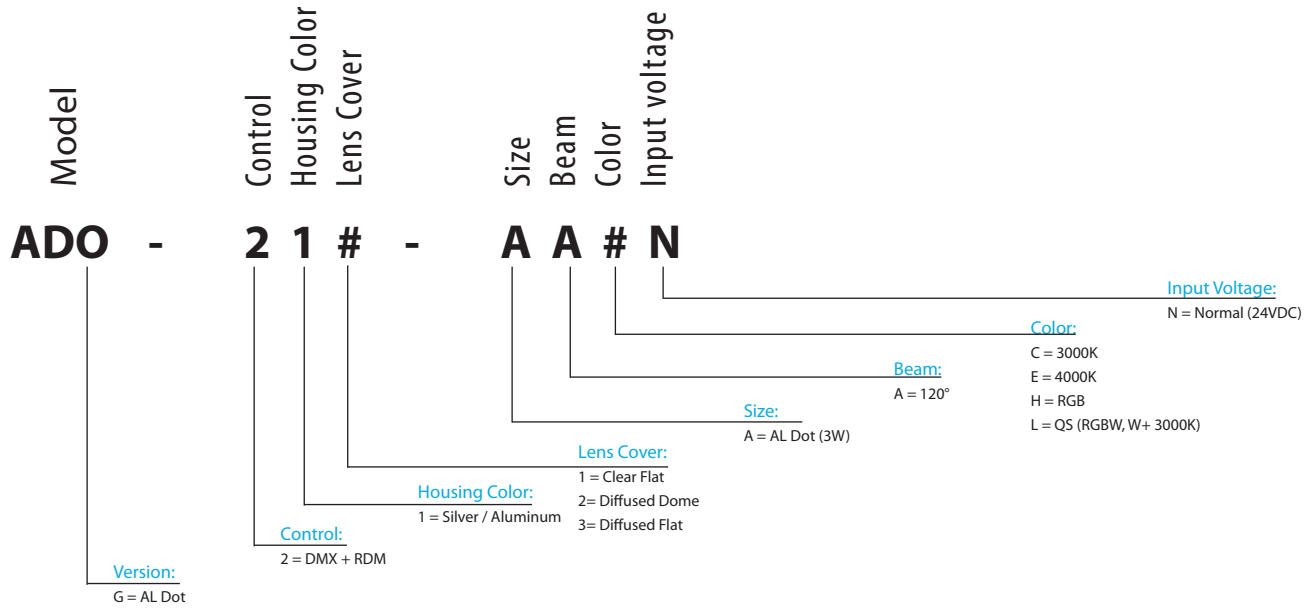

DIMENSIONS

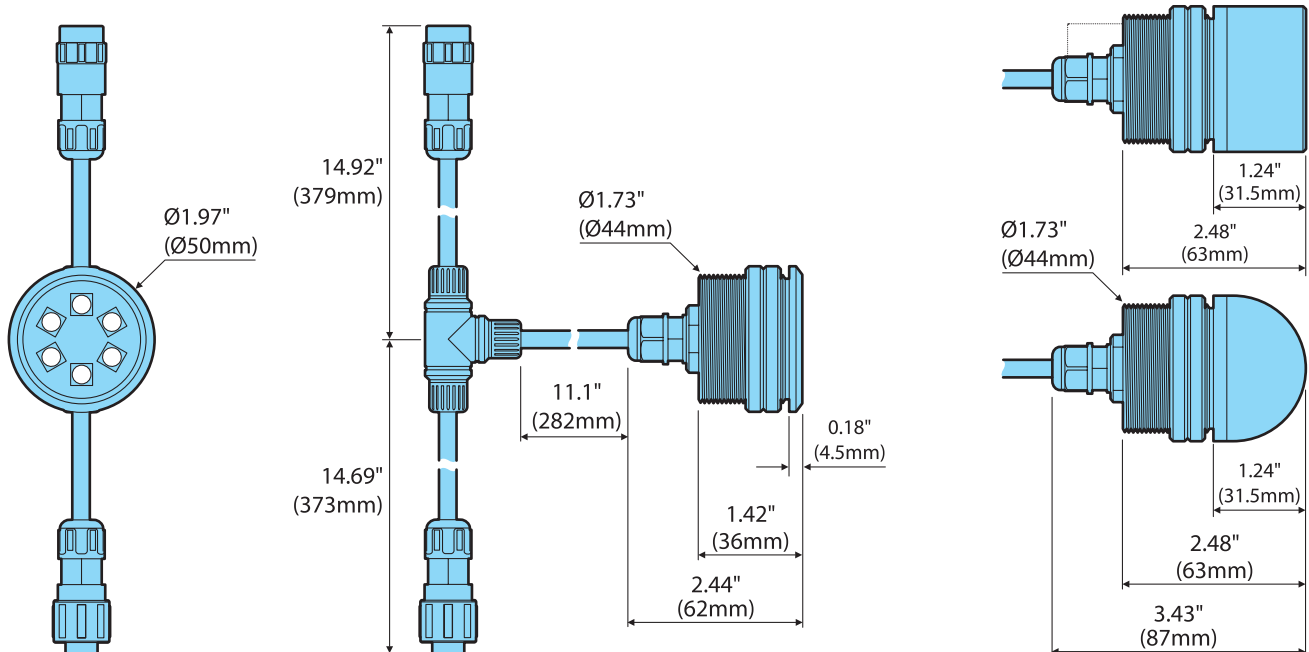

RELATED COMPONENTS

Connection Cables



ADOFC10-V2
10' Feed Cable For AL Dot, Max linkable 50 pcs



ADOLC1-V2
1' (30cm) Link Cable For AL Dot

ADOLC5-V2
5' (1.5m) Link Cable For AL Dot

ADOLC10-V2
10' (3m) Link Cable For AL Dot

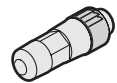

ADOEC-V2
End Cap For AL Dot

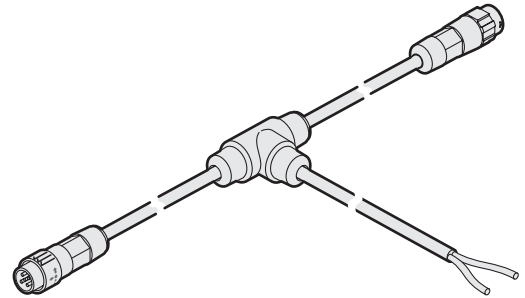

ADOT1-V2
1' "T" Link Cable For AL Dot
(extends DMX link while injecting a new 24VDC line)

Power Supplies

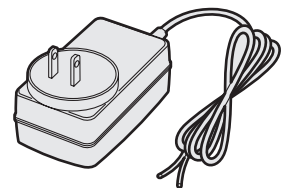

APS-30-24
Powers 1 x 8 Unit Run
30W, 24VDC, Dry location, Wall Plug
100-240VAC (47-63Hz) Input

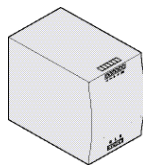

APS-240-24
Powers 1 x 50 Unit Runs
240W, 24VDC, Dry location, DIN Rail Mount
115-230VAC (47-63Hz) Input

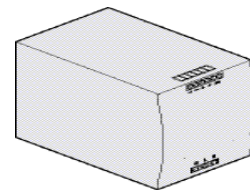

APS-480-24
Powers 3 x 50 Unit Runs
480W, 24VDC, Dry location, DIN Rail Mount
115-230VAC (47-63Hz) Input

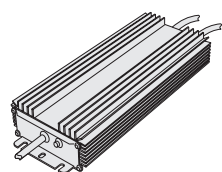

APS-300-24-IP
Powers 2 x 50 Unit Run
300W, 24VDC, IP66 Wet location,
100-277VAC Input

Fixture Setup Accessories

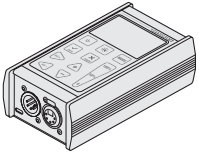

XMT350
DMX + RDM Addressing and Testing Tool

WIRING

The maximum number of fixtures that can be connected in a single series run is 50 when they are directly connected to each other (which will result in their total cable length being 100 feet (30m):

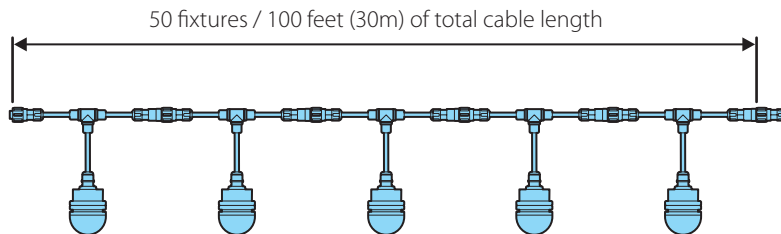

Where greater distances are required between AL Dots, you can use extra link cables. However, the total number of AL Dot fixtures must be reduced accordingly so that the total cable run does not exceed 100 feet (30m).

For instance, if 1' (30cm) link cables were used between each of the AL Dot fixtures, the total number of fixtures would need to be reduced to 33:

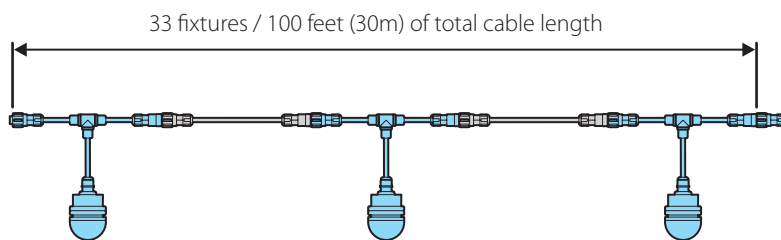

PHOTOMETRICS

Color Temp	Lumens	Center Candela	Efficacy (l/pw)	CRI (Ra)	CRI (r9)
RGB (Clear)	31.8	11.8	23.26	N/A	N/A
3000K (Clear)	75.1	27.7	55.22	83.1	10
4000K (Clear)	98.2	34.5	71.47	77.4	-15.3