

3G LIGHTING

3G-4PLI-DI

3.5" LINEAR PENDANT
DIRECT/INDIRECT
TUNABLE WHITE & RGBW



3.5" aperture with one piece extruded aluminum housing
Individual or continuous runs available in multiple run configurations
Direct/Indirect distribution with multiple lumen output options
LED system with performance up to 156 lumens per watt
Extruded acrylic lens available in flush, 1" and 2" drop lens options
Widespread and asymmetric optics available
1% dimming standard with several integral driver options



ORDERING INFORMATION

CAT. NO	LED SOURCE	LUMEN OUTPUT (DIRECT)	LUMEN OUTPUT (INDIRECT)	CRI
3G-4PLI-DI	TW - TUNABLE WHITE (2700K-6500K)	L250 - LOW OUTPUT (250 LM/FT) ² L500 - MEDIUM OUTPUT (500 LM/FT) L750 - HIGH OUTPUT (750 LM/FT) L1000 - VERY HIGH OUTPUT (1000 LM/FT) ³ LC ____ - CUSTOM OUTPUT (SPECIFY LM/FT) [*]	L250 - LOW OUTPUT (250 LM/FT) ² L500 - MEDIUM OUTPUT (500 LM/FT) L750 - HIGH OUTPUT (750 LM/FT) L1000 - VERY HIGH OUTPUT (1000 LM/FT) ³ LC ____ - CUSTOM OUTPUT (SPECIFY LM/FT) [*]	S80 - 83+ CRI H90 - 93+ CRI ¹
	RGBW - INFINITE COLOUR ¹ (3500K WHITE)	<p>*Specify custom lumen outputs in 50lm increments (ie: LC600, LC650, LC700) Custom output cannot exceed LC1000 Lumen outputs suitable for white LED source only</p> <p>*Specify custom lumen outputs in 50lm increments (ie: LC600, LC650, LC700) Custom output cannot exceed LC1000 Lumen outputs suitable for white LED source only</p>		
VOLTAGE	DRIVER	LENS OPTION (DIRECT)	LENS OPTION (INDIRECT)	FINISH
UNV - 120-277V	DO1 - 0-10V (100-0.1%) DALI - DALI (eldoLED, 100-1%) DMX - DMX (eldoLED, 100-1%) ¹ DHLT - LUTRON T SERIES (100-0.1%) (2 CHANNEL TUNABLE WHITE)	FL - FLUSH DD1 - 1" DROP LENS DD2 - 2" DROP LENS DASY - ASYMMETRIC OPTIC ¹	FL - FLUSH WSO - WIDESPREAD OPTIC ¹ ASY - ASYMMETRIC OPTIC ^{1,3}	WH - WHITE SV - SILVER BK - BLACK All mounting canopies provided in white as standard
CABLE LENGTH	CIRCUITING	OPTIONS	LENGTH (FEET)	
60 - 60" 120 - 120"	1C - 1 CIRCUIT 2C - 2 CIRCUIT	EMC - EMERGENCY CIRCUIT ⁴	S - ____' (STRAIGHT RUN) [*] L - ____'X ____' (L-SHAPE) U - ____'X ____'X ____' (U-SHAPE) R - ____'X ____' (RECTANGLE/SQUARE) T - ____'X ____' (T-SHAPE) X - ____'X ____' (X-SHAPE) CUS - ____ (CUSTOM LAYOUT - PROVIDE DRAWING)	
			* Individual units available from 2' to 8' Continuous runs available in 1' increments	

¹ RGBW LED source available with S80 (83+CRI) and DMX driver option only. Not available with widespread, asymmetric, or EM options

² L250 (250LM/FT) not available in 2' and 3' lengths. Specify LC400 for 2' and 3' fixture lengths when outputs lower than 500LM/FT are required

³ L1000 (1000LM/FT) not available for H90 (93+ CRI) or indirect asymmetric option

⁴ EMC (emergency circuit) options available for tunable white LED source only. Not available with RGBW

3GT - Tunable White

3GB - RGBW

JUNE 7, 2020



3G-4PLI-DI
 3.5" LINEAR PENDANT
 DIRECT/INDIRECT
 TUNABLE WHITE & RGBW

PERFORMANCE CHART BASED ON 4' LENGTH WITH FLUSH LENS (TUNABLE WHITE AND 83+ CRI)

LENS OPTION	DELIVERED LUMENS (LM/FT)			SYSTEM WATTS (W/FT)			EFFICACY (LPW)			
	DIRECT + INDIRECT	DIRECT	INDIRECT	TOTAL	DIRECT	INDIRECT	TOTAL	DIRECT	INDIRECT	TOTAL
2700K		250	250	500	1.9	1.3	3.2	126	162	141
		500	500	1000	3.8	3.0	6.8	121	158	137
		750	750	1500	5.8	4.3	10.1	119	157	135
		1000	1000	2000	8.0	6.2	14.2	118	155	134
3500K		250	250	500	1.9	1.3	3.2	135	164	147
		500	500	1000	3.8	3.0	6.8	130	161	144
		750	750	1500	5.8	4.3	10.1	127	161	141
		1000	1000	2000	8.0	6.2	14.2	123	159	139
6500K		250	250	500	1.9	1.3	3.2	147	169	156
		500	500	1000	3.8	3.0	6.8	145	165	154
		750	750	1500	5.8	4.3	10.1	138	166	150
		1000	1000	2000	8.0	6.2	14.2	132	164	146
EFFICACY (LPW)	CRI	Multiplier								
ADJUSTMENT FACTOR	93+	0.88								



3G-4PLI-DI
3.5" LINEAR PENDANT
DIRECT/INDIRECT
TUNABLE WHITE & RGB

PHOTOMETRY BASED ON 4' LENGTH (83+ CRI AND 3500K SOURCE)

FL + FL - FLUSH (DIRECT) + FLUSH (INDIRECT)

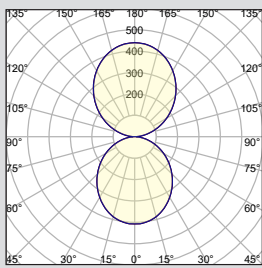

3G-4PLI-DI-TW-L500-L500-FL-FL
DELIVERED LUMENS: 1000LM/FT (4000LM)
SYSTEM WATTS: 6.8W/FT (27.2W)
EFFICACY: 144LPW
CRI: 83+
CCT: 3500K
LENS OPTION: FLUSH (DIRECT)
FLUSH (INDIRECT)

DD1 + FL - 1" DROP (DIRECT) + FLUSH (INDIRECT)

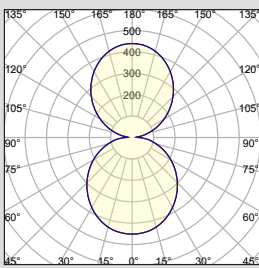

3G-4PLI-DI-TW-L500-L500-DD1-FL
DELIVERED LUMENS: 1000LM/FT (4000LM)
SYSTEM WATTS: 6.8W/FT (27.2W)
EFFICACY: 146LPW
CRI: 83+
CCT: 3500K
LENS OPTION: 1" DROP (DIRECT)
FLUSH (INDIRECT)

FL + WSO - FLUSH (DIRECT) + WIDESPREAD OPTIC (INDIRECT)

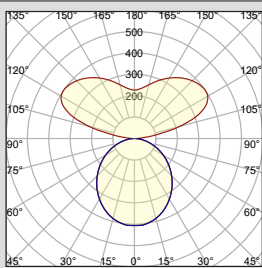

3G-4PLI-DI-TW-L500-L500-FL-WSO
DELIVERED LUMENS: 1000LM/FT (4000LM)
SYSTEM WATTS: 6.8W/FT (27.2W)
EFFICACY: 134LPW
CRI: 83+
CCT: 3500K
LENS OPTION: FLUSH (DIRECT)
WSO (INDIRECT)

DD2 + FL - 2" DROP (DIRECT) + FLUSH (INDIRECT)

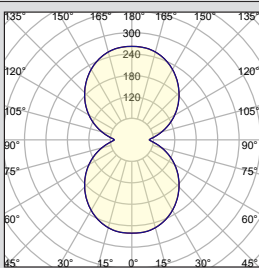

3G-4PLI-DI-TW-L500-L500-DD2-FL
DELIVERED LUMENS: 1000LM/FT (4000LM)
SYSTEM WATTS: 6.8W/FT (27.2W)
EFFICACY: 148LPW
CRI: 83+
CCT: 3500K
LENS OPTION: 2" DROP (DIRECT)
FLUSH (INDIRECT)

FL + ASY - FLUSH (DIRECT) + ASYMMETRIC (INDIRECT)

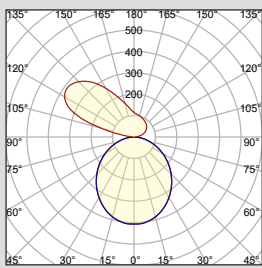

3G-4PLI-DI-TW-L500-L500-FL-ASY
DELIVERED LUMENS: 1000LM/FT (4000LM)
SYSTEM WATTS: 6.9W/FT (27.6W)
EFFICACY: 110LPW
CRI: 83+
CCT: 3500K
LENS OPTION: FLUSH (DIRECT)
ASY (INDIRECT)

DASY + FL - ASYMMETRIC (DIRECT) + FLUSH (INDIRECT)

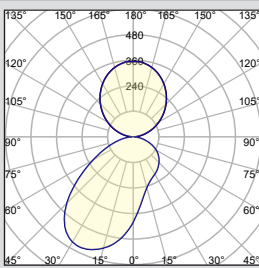

3G-4PLI-DI-TW-L500-L500-DASY-FL
DELIVERED LUMENS: 1000LM/FT (4000LM)
SYSTEM WATTS: 6.8W/FT (27.2W)
EFFICACY: 141LPW
CRI: 83+
CCT: 3500K
LENS OPTION: DASY (DIRECT)
FLUSH (INDIRECT)



3G-4PLI-DI
3.5" LINEAR PENDANT
DIRECT/INDIRECT
TUNABLE WHITE & RGBW

PERFORMANCE CHART BASED ON 4' LENGTH (RGBW WITH 83+ CRI AND 3500K SOURCE)

LENS OPTION	DELIVERED LUMENS (LM/FT)			SYSTEM WATTS (W/FT)			EFFICACY (LPW)		
	DIRECT	INDIRECT	TOTAL	DIRECT	INDIRECT	TOTAL	DIRECT	INDIRECT	TOTAL
3500K	250	250	500	2.2	2.2	4.4	119	139	129
	500	500	1000	4.6	4.6	9.2	113	138	125
	750	750	1500	7.8	7.8	15.6	96	133	114
	1000	1000	2000	11.3	11.3	22.6	89	127	104

LUMINOUS INTENSITY PER LED	RGB	INTENSITY Min - Max (mcd)
	RED	355 - 805
	GREEN	710 - 1400
	BLUE	140 - 355



3G-4PLI-DI
 3.5" LINEAR PENDANT
 DIRECT/INDIRECT
 TUNABLE WHITE & RGB

DRAWINGS AND DIMENSIONS

FL + FL - FLUSH (DIRECT) + FLUSH (INDIRECT)

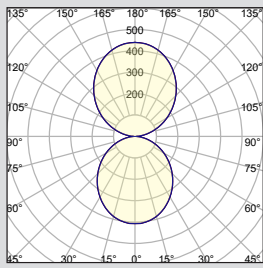

3G-4PLI-DI-RGBW-L500-L500-FL-FL
 DELIVERED LUMENS: 1000LM/FT (4000LM)
 SYSTEM WATTS: 9.2W/FT (36.8W)
 EFFICACY: 125LPW
 CRI: 83+
 CCT: 3500K
 LENS OPTION: FLUSH (DIRECT)
 FLUSH (INDIRECT)

DD1 + FL - 1" DROP (DIRECT) + FLUSH (INDIRECT)

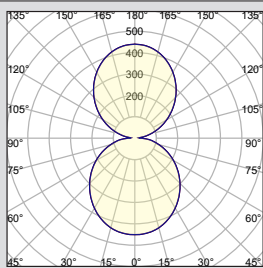

3G-4PLI-DI-RGBW-L500-L500-DD1-FL
 DELIVERED LUMENS: 1000LM/FT (4000LM)
 SYSTEM WATTS: 9.2W/FT (36.8W)
 EFFICACY: 127LPW
 CRI: 83+
 CCT: 3500K
 LENS OPTION: 1" DROP (DIRECT)
 FLUSH (INDIRECT)

DD2 + FL - 2" DROP (DIRECT) + FLUSH (INDIRECT)

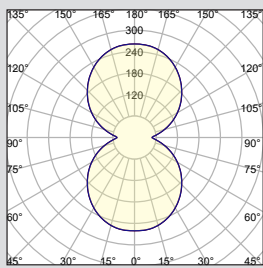

3G-4PLI-DI-RGBW-L500-L500-DD2-FL
 DELIVERED LUMENS: 1000LM/FT (4000LM)
 SYSTEM WATTS: 9.2W/FT (36.8W)
 EFFICACY: 128LPW
 CRI: 83+
 CCT: 3500K
 LENS OPTION: 2" DROP (DIRECT)
 FLUSH (INDIRECT)



3G-4PLI-DI
3.5" LINEAR PENDANT
DIRECT/INDIRECT
TUNABLE WHITE & RGBW

TECHNICAL

HOUSING

Extruded aluminum housing with 3.5" aperture
Machined aluminum end caps add 1/4" to each end of luminaire
Individual units and continuous runs available in 1' increments
24-gauge LED reflector with high reflectance white powder coated finish
Standard polyester powder coated matte white finish
Optional finishes available

OPTICS

Extruded, satin acrylic lens designed for optimal performance and glare control. Up to 8' continuous
Lens options include flush, 1" and 2" drops with illuminated end caps for all drop lenses
High performance widespread and asymmetric optics available
Widespread Optic peak intensity at 120° with optimal distance at 12" from ceiling

ELECTRICAL

Luminaires are pre-wired with factory installed quick connects and branch circuit wiring
Multiple driver options available for tunable white LED system
DMX driver option for RGBW system with RDM control and 100-0% dimming range
All drivers are integral and easily accessible through luminaire aperture

LED SYSTEM FOR TUNABLE WHITE (TW)

Proprietary LED system with color consistency <3 SDCM
2700K-6500K CCT range
Standard 83+CRI. Optional 93+CRI. (R9 value of 56 for 93+CRI)
L90 >60,000 hours
5 Year Warranty

LED SYSTEM FOR RGBW

Proprietary LED system with color consistency <3 SDCM
White LED available in 35K with 83+ CRI
L80 >72,000 hours
Red (335-805 mcd)
Green (710-1400 mcd)
Blue (140-355 mcd)
5 Year Warranty

MOUNTING

Toolless installation with 3G's proprietary mounting system
Internal, toolless joiner system (latch and hook) easily connects multiple sections together
LED reflectors remain within each fixture section during installation with 3G's click and lock spring system
Adjustable aircraft cable suspension with locking fasteners (60" length standard)
Standard, 18-gauge, 5 conductor single circuit power feed (clear braided finish)
All mounting canopies provided in white finish as standard
Suitable for various architectural ceilings (see mounting details)
Fixture weight: +/- 3 lb/ft

LISTING

ETL listed and tested to cUL standards. Suitable for dry and damp locations

WARRANTY

5 Year Warranty on LED and drivers
Manufacturer 1 Year Warranty for defects in material and workmanship under normal use
Ambient temperature at fixture should not exceed 25°C



3G-4PLI-DI
3.5" LINEAR PENDANT
DIRECT/INDIRECT
TUNABLE WHITE & RGBW

DRAWINGS AND DIMENSIONS

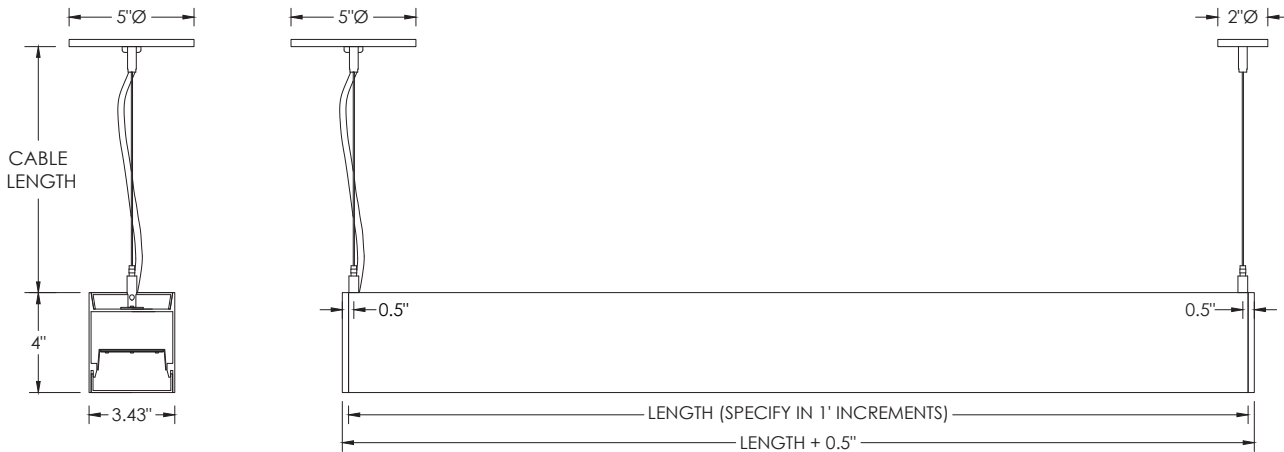

LENS OPTION

DIRECT LENS OPTION

FL - FLUSH DD1 - 1" DROP DD2 - 2" DROP DASY - ASYMMETRIC

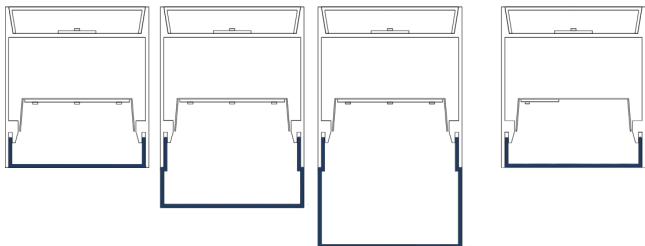

INDIRECT LENS OPTION

FL - FLUSH WSO - WIDESPREAD ASY - ASYMMETRIC

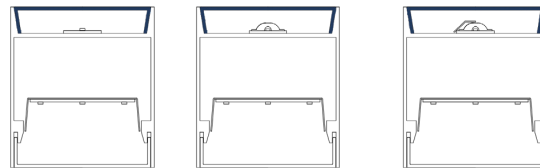

PATTERNS

Specify pattern shape and overall dimensions as shown below. Available in 1' increments only
Patterns are connected with fully illuminated 12"x12" L, T, and X-shaped sections

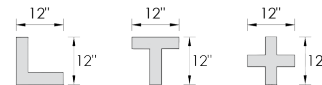

L-SHAPE	U-SHAPE	RECTANGLE/SQUARE	T-SHAPE	X-SHAPE
Provide dimensions of AxB Example: L - 6'x8'	Provide dimensions of AxBxC Example: U - 8'x10'x6'	Provide dimensions of AxB Example: R - 10'x8'	Provide dimensions of AxB Example: T - 14'x6'	Provide dimensions of AxB Example: X - 14'x14'



3G-4PLI-DI
3.5" LINEAR PENDANT
DIRECT/INDIRECT
TUNABLE WHITE & RGBW

TYPICAL SECTION MOUNTING (AVAILABLE IN 1' INCREMENTS AS STANDARD)

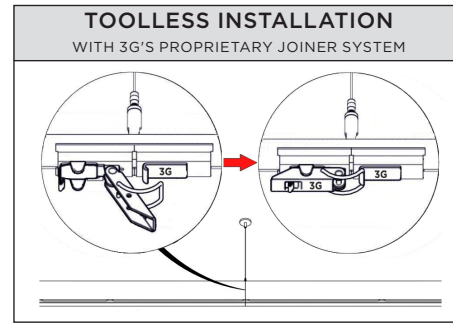
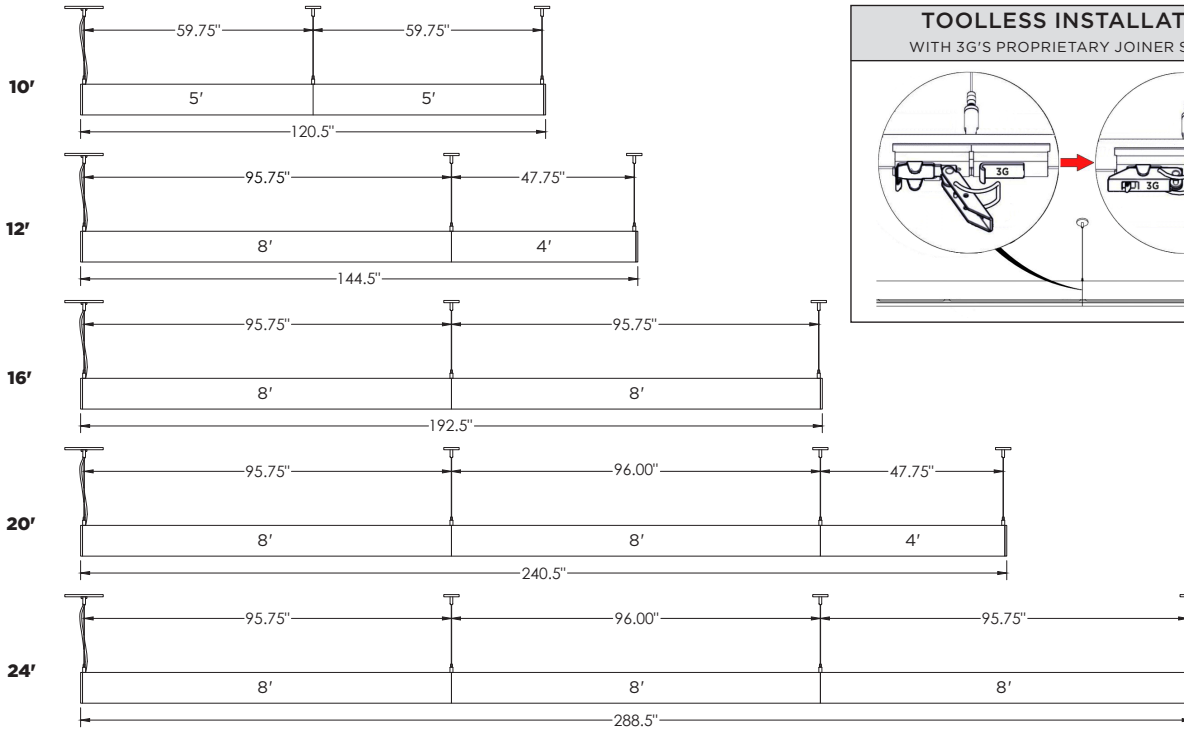

MOUNTING DETAILS

